

TEST REPORT

CERTIFICATE OF CONFORMITY

Standard: EN 50121-1: 2017
EN 50121-3-2: 2016+A1:2019
EN 50155: 2021 (EMC Part only)
EN 61000-3-2: 2014, Class A
EN IEC 61000-3-2: 2019+A1:2021, Class A
EN 61000-3-3: 2013+A1:2019+A2:2021

Report No.: CEBDBO-WTW-P24030474-1

Product: Edge AI Computing System

Brand: Vecow

Model No.: EAC-5000

Series Model: EAC-5000 Series, EAC-5XXXXXXXXXXXXXXXXX ("X" can be 0-9, A-Z, - or blank for marketing purpose)

Received Date: 2024/3/15

Test Date: 2024/3/15 ~ 2024/4/11

Issued Date: 2024/4/24

Applicant: Vecow Co., Ltd.

Address: 3F., No. 10, Jiankang Rd., Zhonghe Dist., New Taipei City 23586, Taiwan

Issued By: Bureau Veritas Consumer Products Services (H.K.) Ltd., Taoyuan Branch
Lin Kou Laboratories

Lab Address: No. 47-2, 14th Ling, Chia Pau Vil., Lin Kou Dist., New Taipei City, Taiwan

Test Location: No. 47-2, 14th Ling, Chia Pau Vil., Lin Kou Dist., New Taipei City, Taiwan

Approved by:

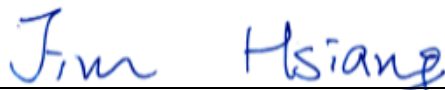

Jim Hsiang / Associate Technical Manager

Date:

2024/4/24

This test report consists of 61 pages in total. It may be duplicated completely for legal use with the approval of the applicant. It should not be reproduced except in full, without the written approval of our laboratory. The test results in the report only apply to the tested sample. The test results in this report are traceable to the national or international standards.

Prepared by : Jessica Cheng / Senior Specialist



This report is governed by, and incorporates by reference, the Conditions of Testing as posted at the date of issuance of this report at <http://www.bureauveritas.com/home/about-us/our-business/cps/about-us/terms-conditions/>, and is intended for your exclusive use. Any copying or replication of this report to or for any other person or entity, or use of our name or trademark, is permitted only with our prior written permission. This report sets forth our findings solely with respect to the test samples identified herein. The results set forth in this report are not indicative or representative of the quality or characteristics of the lot from which a test sample was taken or any similar or identical product unless specifically and expressly noted. Our report includes all of the tests requested by you and the results thereof based upon the information that you provided to us. Measurement uncertainty is only provided upon request for accredited tests. Statements of conformity are based on simple acceptance criteria without taking measurement uncertainty into account, unless otherwise requested in writing. You have 60 days from date of issuance of this report to notify us of any material error or omission caused by our negligence or if you require measurement uncertainty; provided, however, that such notice shall be in writing and shall specifically address the issue you wish to raise. A failure to raise such issue within the prescribed time shall constitute your unqualified acceptance of the completeness of this report, the tests conducted and the correctness of the report contents.

Table of Contents

Release Control Record	4
1 Certificate.....	5
2 Summary of Test Results	6
2.1 Performance Criteria	6
2.2 Measurement Uncertainty	7
2.3 Supplementary Information	7
3 General Information	8
3.1 Description of EUT	8
3.2 Primary Clock Frequencies of Internal Source.....	8
3.3 Features of EUT	8
3.4 Operating Modes of EUT and Determination of Worst Case Operating Mode	9
3.5 Test Program Used and Operation Descriptions	10
3.6 Connection Diagram of EUT and Peripheral Devices	11
3.7 Configuration of Peripheral Devices and Cable Connections	13
4 Test Instruments	15
4.1 Conducted Emissions from Power Ports	15
4.2 Radiated Emissions up to 1 GHz	16
4.3 Radiated Emissions above 1 GHz.....	17
4.4 Harmonic Current Measurement	17
4.5 Voltage Fluctuations and Flicker Measurement	18
4.6 Electrostatic Discharges (ESD)	18
4.7 Radio Frequency Electromagnetic Field (RS).....	19
4.8 Fast Transients Common Mode (EFT).....	20
4.9 Surges	20
4.10 Radio Frequency Common Mode (CS).....	20
5 Limits of Test Items.....	22
5.1 Conducted Emissions from Power Ports	22
5.2 Radiated Emissions up to 1 GHz	22
5.3 Radiated Emissions above 1 GHz.....	22
5.4 Harmonic Current Measurement	23
5.5 Voltage Fluctuations and Flicker Measurement	24
5.6 General immunity requirements	24
6 Test Arrangements.....	25
6.1 Conducted Emissions from Power Ports	25
6.2 Radiated Emissions up to 1 GHz	26
6.3 Radiated Emissions above 1 GHz.....	27
6.4 Harmonic Current Measurement	28
6.5 Voltage Fluctuations and Flicker Measurement	28
6.6 Electrostatic Discharges (ESD)	29
6.7 Radio Frequency Electromagnetic Field (RS).....	31
6.8 Fast Transients Common Mode (EFT).....	32
6.9 Surges	33
6.10 Radio Frequency Common Mode (CS).....	34
7 Test Results of Test Item	35
7.1 Conducted Emissions from Power Ports	35
7.2 Radiated Emissions up to 1 GHz	37
7.3 Radiated Emissions above 1 GHz.....	39
7.4 Harmonic Current Measurement	41
7.5 Voltage Fluctuations and Flicker Measurement	42
7.6 Electrostatic Discharges (ESD)	43
7.7 Radio Frequency Electromagnetic Field (RS).....	47
7.8 Fast Transients Common Mode (EFT).....	48
7.9 Surges	49



7.10	Radio Frequency Common Mode (CS)	50
8	Pictures of Test Arrangements	51
8.1	Conducted Emissions from Power Ports	51
8.2	Radiated Emissions up to 1 GHz	52
8.3	Radiated Emissions above 1 GHz.....	53
8.4	Electrostatic Discharges (ESD)	54
8.5	Radio Frequency Electromagnetic Field (RS).....	55
8.6	Fast Transients Common Mode (EFT)	56
8.7	Surges	58
8.8	Radio Frequency Common Mode (CS)	59
9	Information of the Testing Laboratories	61



Release Control Record

Issue No.	Description	Date Issued
CEBDBO-WTW-P24030474-1	Original release.	2024/4/24

1 Certificate

Product:	Edge AI Computing System
Brand:	Vecow
Test Model:	EAC-5000
Series Model:	EAC-5000 Series, EAC-5XXXXXXXXXXXXXXXXX ("X" can be 0-9, A-Z, - or blank for marketing purpose)
Sample Status:	Engineering sample
Applicant:	Vecow Co., Ltd.
Test Date:	2024/3/15 ~ 2024/4/11
Standard:	EN 50121-1: 2017 EN 50121-3-2: 2016+A1:2019 EN 50155: 2021 (EMC Part only) EN 61000-3-2: 2014, Class A EN IEC 61000-3-2: 2019+A1:2021, Class A EN 61000-3-3: 2013+A1:2019+A2:2021
Measurement procedure:	EN 61000-4-2: 2009 / IEC 61000-4-2: 2008 ED. 2.0 EN IEC 61000-4-3: 2020 / IEC 61000-4-3: 2020 ED. 4.0 EN 61000-4-4: 2012 / IEC 61000-4-4: 2012 ED. 3.0 EN 61000-4-5: 2014+A1:2017 / IEC 61000-4-5: 2017 ED. 3.1 EN 61000-4-6: 2014+AC:2015 / IEC 61000-4-6: 2013 ED. 4.0

The above equipment has been tested by **Bureau Veritas Consumer Products Services (H.K.) Ltd., Taoyuan Branch**, and found compliance with the requirement of the above standards. The test record, data evaluation & Equipment Under Test (EUT) configurations represented herein are true and accurate accounts of the measurements of the sample's EMC characteristics under the conditions specified in this report.

2 Summary of Test Results

The test items that the EUT need to perform in accordance with its interfaces, evaluated functions are as follows:

Standard	Test Item	Result	Remark
EN 50121-3-2, clause 7	Conducted Emissions from Power Ports	Pass	Minimum passing margin is -50.27 dB at 21.39100 MHz
EN 50121-3-2, clause 7	Radiated Emissions up to 1 GHz	Pass	Minimum passing margin is -5.69 dB at 662.47 MHz
EN 50121-3-2, clause 7	Radiated Emissions above 1 GHz	Pass	Minimum passing margin is -11.61 dB at 1418.68 MHz
EN 61000-3-2 EN IEC 61000-3-2	Harmonic Current Measurement	Pass	The power consumption of EUT is less than 75W and no limits are applied.
EN 61000-3-3	Voltage Fluctuations and Flicker Measurement	Pass	$P_{st} \leq 1.00$ $d_{max} \leq 4.00\%$ $P_{lt} \leq 0.65$ $d_c \leq 3.30\%$ $T_{max} \leq 500$ ms
IEC 61000-4-2	Electrostatic Discharges (ESD)	Pass	For EN 50121-3-2 Performance Criteria B
IEC 61000-4-3	Radio Frequency Electromagnetic Field (RS)	Pass	For EN 50121-3-2 Performance Criteria A
IEC 61000-4-4	Fast Transients Common Mode (EFT)	Pass	For EN 50121-3-2 Performance Criteria A
IEC 61000-4-5	Surges	Pass	For EN 50121-3-2 Performance Criteria B
IEC 61000-4-6	Radio Frequency Common Mode (CS)	Pass	For EN 50121-3-2 Performance Criteria A

Note: Determining compliance based on the results of the compliance measurement, not taking into account measurement instrumentation uncertainty.

2.1 Performance Criteria

General Performance Criteria

The general performance criteria apply for those ports for which no specific performance criteria are defined (e.g. auxiliary ports) in the report.

Performance criterion A: The apparatus shall continue to operate as intended during and after the test. No degradation of performance or loss of function is allowed below a performance level specified by the manufacturer, when the apparatus is used as intended. The performance level may be replaced by a permissible loss of performance. If the minimum performance level or the permissible performance loss is not specified by the manufacturer, either of these may be derived from the product description and documentation, and from what the user may reasonably expect from the apparatus if used as intended.

Performance criterion B: The apparatus shall continue to operate as intended after the test. No degradation of performance or loss of function is allowed below a performance level specified by the manufacturer, when the apparatus is used as intended. The performance level may be replaced by a permissible loss of performance. During the test, degradation of performance is however allowed. No change of actual operating state or stored data is allowed. If the minimum performance level or the permissible performance loss is not specified by the manufacturer, either of these may be derived from the product description and documentation, and from what the user may reasonably expect from the apparatus if used as intended.

Performance criterion C: Temporary loss of function is allowed, provided the function is selfrecoverable or can be restored by the operation of the controls.

2.2 Measurement Uncertainty

Where relevant, the following measurement uncertainty levels have been estimated for tests performed on the EUT as specified in CISPR 16-4-2:

Measurement	Specification	Expanded Uncertainty (k=2) (±)	Maximum allowable uncertainty (±)
Conducted Emissions from Power Ports	9 kHz ~ 30 MHz	2.88 dB	3.4 dB (U_{CISPR})
Radiated Emissions up to 1 GHz	30 MHz ~ 1 GHz	3m : 5.62 dB 10m : 4.26 dB	6.3 dB (U_{CISPR})
Radiated Emissions above 1 GHz	1 GHz ~ 6 GHz	4.72 dB	5.2 dB (U_{CISPR})

The other instruments specified are routine verified to remain within the calibrated levels, no measurement uncertainty is required to be calculated.

2.3 Supplementary Information

There is not any deviation from the test standards for the test method, and no modifications required for compliance.

3 General Information

3.1 Description of EUT

Product	Edge AI Computing System
Brand	Vecow
Test Model	EAC-5000
Series Model	EAC-5000 Series, EAC-5XXXXXXXXXXXXXXXXX ("X" can be 0-9, A-Z, - or blank for marketing purpose)
Sample Status	Engineering sample
Power Supply Rating	24Vdc from adapter

Note:

The EUT consumes power from the following adapter:

AC Adapter 1		
Brand	Model	Specification
FSP	FSP120-AAAN2	AC Input : 100-240V, 1.8A, 50-60Hz (3pin) DC Output : 24V, 5A (1.3m with one core)

3.2 Primary Clock Frequencies of Internal Source

The highest frequency generated or used within the EUT or on which the EUT operates or tunes is 2.2 GHz, provided by Vecow Co., Ltd., for detailed internal source, please refer to the manufacturer's specifications.

3.3 Features of EUT

The tests reported herein were performed according to the method specified by Vecow Co., Ltd., for detailed feature description, please refer to the manufacturer's specifications or user's manual.

Please refer to appendix of the report if the applicant has provided additional descriptions of the EUT.

The EUT was configured with the following key components:

Item	Description
CPU	NVIDIA® Jetson AGX Orin™ 64GB
GPU	2048-core NVIDIA Ampere™ GPU with 64 Tensor Cores
RAM	64GB LPDDR5 DRAM
OS	Ubuntu 20.04

3.4 Operating Modes of EUT and Determination of Worst Case Operating Mode

The EUT has been pre-tested under following test modes.

Test Condition	
Mode	Radiated Emissions up to 1 GHz
1	HDMI:3840*2160,60Hz,Lan link
Notes:	
1. There are both AC 230V/50Hz and AC 110V/60Hz to be pre-tested then AC 110V/ 60Hz has the highest emission value.	
2. There are both standby mode and normal mode to be pre-tested then normal mode has the highest emission value.	

Test modes are presented in the report as below.

Test Condition	
Mode	Conducted Emissions from Power Ports
A	HDMI:3840*2160,60Hz,Lan link + Input Power(230 Vac, 50 Hz)
Mode	Radiated Emissions up to 1 GHz
A	HDMI:3840*2160,60Hz,Lan link + Input Power(110 Vac, 60 Hz)
Mode	Radiated Emissions above 1 GHz
A	HDMI:3840*2160,60Hz,Lan link + Input Power(110 Vac, 60 Hz)
Mode	Electrostatic Discharges (ESD)
A	HDMI:3840*2160,60Hz,Lan link + Input Power(230 Vac, 50 Hz)
Mode	Radio Frequency Electromagnetic Field (RS)
A	HDMI:3840*2160,60Hz,Lan link + Input Power(230 Vac, 50 Hz)
Mode	Fast Transients Common Mode (EFT)
A	HDMI:3840*2160,60Hz,Lan link + Input Power(230 Vac, 50 Hz)
Mode	Surges
A	HDMI:3840*2160,60Hz,Lan link + Input Power(230 Vac, 50 Hz)
Mode	Radio Frequency Common Mode (CS)
A	HDMI:3840*2160,60Hz,Lan link + Input Power(230 Vac, 50 Hz)

3.5 Test Program Used and Operation Descriptions

For Emission test

- a. Turned on the power of all equipments.
- b. EUT ran a test program (ARM_burn-in_onoff) to enable all functions.
- c. EUT read and wrote messages to/ from internal/ external storage devices.
- d. Laptop (kept at remote area) sent and received messages to/ from EUT via LAN cable.
- e. EUT sent (H) messages to monitor. Then they displayed messages on their screens simultaneously.
- f. EUT sent messages to printer and printed them out.
- g. Steps c-f were repeated.

For Harmonics, Flicker & Immunity test

- a. Turned on the power of all equipments.
- b. EUT ran a test program (ARM_burn-in_onoff) to enable all functions.
- c. EUT read and wrote messages to/ from internal/ external storage devices.
- d. Laptop (kept at remote area) sent and received messages to/ from EUT via LAN cable.
- e. EUT sent (color bars with moving element) messages to monitor. Then they displayed messages on their screens simultaneously.
- f. Steps c-f were repeated.

3.6 Connection Diagram of EUT and Peripheral Devices

For Emission test

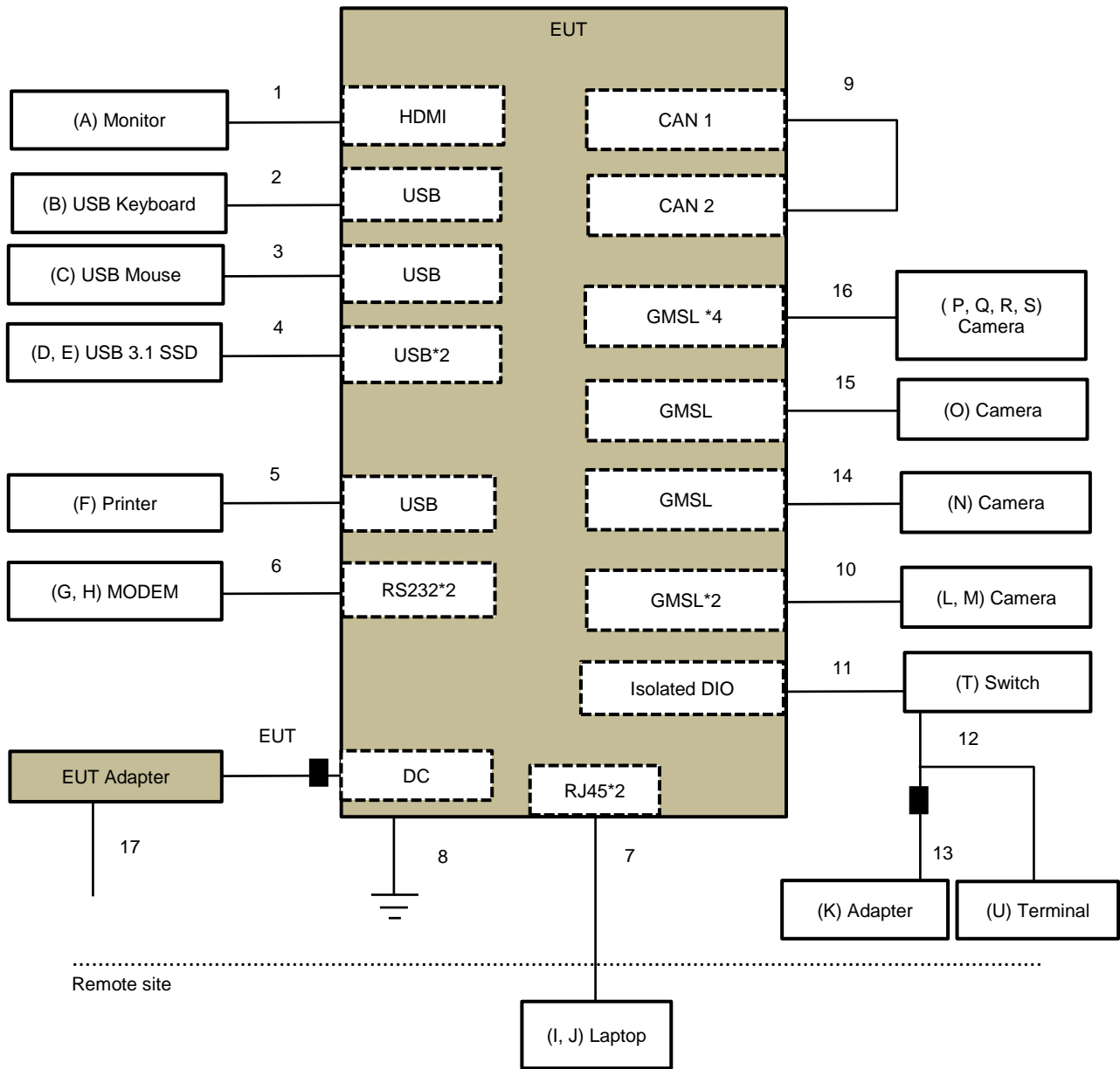

For Harmonics, Flicker & Immunity test

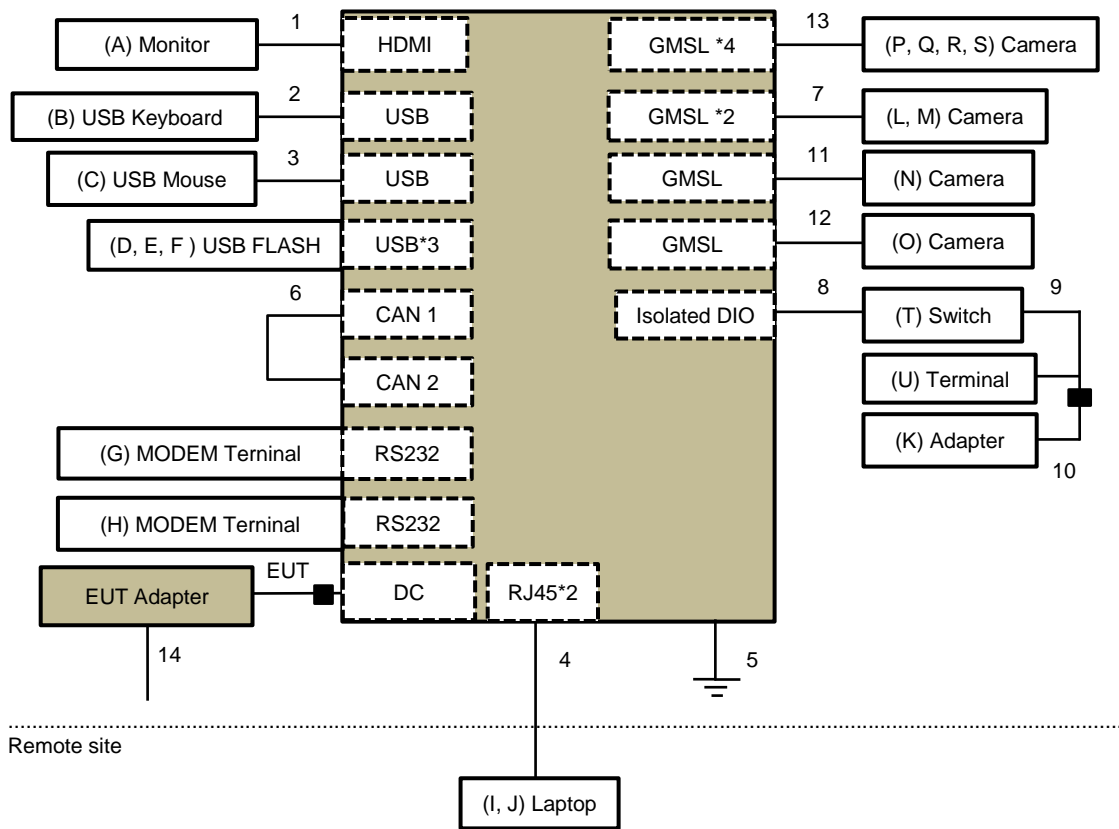

3.7 Configuration of Peripheral Devices and Cable Connections

For Emission test

ID	Product	Brand	Model No.	Serial No.	FCC ID	Remarks
A	Monitor	ASUS	PA279CV	M7LMTF235958	DoC	Provided by Lab
B	USB Keyboard	Dell	KB216t	CN-0W33XP- LO300-7CL-1902	N/A	Provided by Lab
C	USB Mouse	DELL	MOCZUL	CN-049TWY- PRC00-77B- 007Q	N/A	Provided by Lab
D	USB 3.1 SSD	Crucial	CT500X8SSD9	1941E323D095	N/A	Provided by Lab
E	USB 3.1 SSD	Crucial	CT500X8SSD9	1942E32014B5	N/A	Provided by Lab
F	Printer	HP	HP Officejet Pro 251dW	N/A	B94SDGOB1191	Provided by Lab
G	MODEM	ACEEX	1414	980020525	IFAXDM1414	Provided by Lab
H	MODEM	ACEEX	1414	980020526	IFAXDM1414	Provided by Lab
I	Laptop	LENOVO	T480	PF1EK03U	N/A	Provided by Lab
J	Laptop	LENOVO	T480	PF1EZSA2	N/A	Provided by Lab
K	Adapter	FSP	FSP180-AABN3	N/A	N/A	Supplied by applicant
L	Camera	oTo CAM	2641SP-N186M	BJDDB4270010	N/A	Supplied by applicant
M	Camera	oTo CAM	2641SP-C120M	BJDPD6190032	N/A	Supplied by applicant
N	Camera	oTo CAM	2641SP-N73M	BJDBC1070010	N/A	Supplied by applicant
O	Camera	oTo CAM	2641SP-C120M	BJDPD6190033	N/A	Supplied by applicant
P	Camera	oTo CAM	2641SP-C120M	BJDPD6190038	N/A	Supplied by applicant
Q	Camera	oTo CAM	2641SP-L61M	BJDABA120026	N/A	Supplied by applicant
R	Camera	oTo CAM	2641SP-C120M	BJDPD6190037	N/A	Supplied by applicant
S	Camera	oTo CAM	2641SP-L61M	BJDAB2010021	N/A	Supplied by applicant
T	Switch	N/A	N/A	N/A	N/A	Supplied by applicant
U	Terminal	N/A	N/A	N/A	N/A	Supplied by applicant

ID	Cable Descriptions	Qty.	Length (m)	Shielding (Yes/No)	Cores (Qty.)	Remarks
1	HDMI	1	2	Y	0	Provided by Lab
2	USB	1	1.8	Y	0	Provided by Lab
3	USB	1	1.8	Y	0	Provided by Lab
4	USB	2	1	Y	0	Provided by Lab
5	USB	1	1.8	Y	0	Provided by Lab
6	RS232	2	1.5	Y	0	Provided by Lab
7	Cat. 5e	2	10	Y	0	Provided by Lab
8	GND (PE)	1	1.5	N	0	Supplied by applicant
9	Data	1	0.02	N	0	Supplied by applicant
10	Coaxial	2	10	Y	0	Supplied by applicant
11	Data	1	1.2	N	0	Supplied by applicant
12	Data	1	1.2	N	0	Supplied by applicant
13	Power	1	1.2	N	1	Supplied by applicant
14	Coaxial	1	1	Y	0	Supplied by applicant
15	Coaxial	1	1.5	Y	0	Supplied by applicant
16	Coaxial	4	2	Y	0	Supplied by applicant
17	Power	1	1.8	N	0	Provided by Lab

For Harmonics, Flicker & Immunity test

ID	Product	Brand	Model No.	Serial No.	FCC ID	Remarks
A	Monitor	vita	VT-270JTG2	204270JTFF002	DoC	Provided by Lab
B	USB Keyboard	HP	KBAR211	N/A	N/A	Provided by Lab
C	USB Mouse	Microsoft	MSK-1113(B)	N/A	N/A	Provided by Lab
D	USB Flash	KINGSTON	DTKN/32GB	N/A	N/A	Provided by Lab
E	USB Flash	KINGSTON	DTKN/32GB	N/A	N/A	Provided by Lab
F	USB Flash	KINGSTON	DTKN/32GB	N/A	N/A	Provided by Lab
G	MODEM Terminal	N/A	N/A	N/A	N/A	Provided by Lab
H	MODEM Terminal	N/A	N/A	N/A	N/A	Provided by Lab
I	Laptop	Lenovo	L470	PF0VTGKS	N/A	Provided by Lab
J	Laptop	Lenovo	X250	PC04V58E	N/A	Provided by Lab
K	Adapter	FSP	FSP180-AABN3	N/A	N/A	Supplied by applicant
L	Camera	oTo CAM	2641SP-N186M	BJDDB4270010	N/A	Supplied by applicant
M	Camera	oTo CAM	2641SP-C120M	BJDPD6190032	N/A	Supplied by applicant
N	Camera	oTo CAM	2641SP-N73M	BJDBC1070010	N/A	Supplied by applicant
O	Camera	oTo CAM	2641SP-C120M	BJDPD6190033	N/A	Supplied by applicant
P	Camera	oTo CAM	2641SP-C120M	BJDPD6190038	N/A	Supplied by applicant
Q	Camera	oTo CAM	2641SP-L61M	BJDABA120026	N/A	Supplied by applicant
R	Camera	oTo CAM	2641SP-C120M	BJDPD6190037	N/A	Supplied by applicant
S	Camera	oTo CAM	2641SP-L61M	BJDAB2010021	N/A	Supplied by applicant
T	Switch	N/A	N/A	N/A	N/A	Supplied by applicant
U	Terminal	N/A	N/A	N/A	N/A	Supplied by applicant

ID	Cable Descriptions	Qty.	Length (m)	Shielding (Yes/No)	Cores (Qty.)	Remarks
1	HDMI	1	2	Y	0	Provided by Lab
2	USB	1	1.8	Y	0	Provided by Lab
3	USB	1	1.8	Y	0	Provided by Lab
4	Cat. 5e	2	10	Y	0	Provided by Lab
5	GND (PE)	1	1.5	N	0	Supplied by applicant
6	Data	1	0.02	N	0	Supplied by applicant
7	Coaxial	2	10	Y	0	Supplied by applicant
8	Data	1	1.2	N	0	Supplied by applicant
9	Data	1	1.2	N	0	Supplied by applicant
10	Power	1	1.2	N	1	Supplied by applicant
11	Coaxial	1	1	Y	0	Supplied by applicant
12	Coaxial	1	1.5	Y	0	Supplied by applicant
13	Coaxial	4	2	Y	0	Supplied by applicant
14	Power	1	1.8	N	0	Provided by Lab

4 Test Instruments

The calibration interval of the all test instruments are 12 months and the calibrations are traceable to NML/ROC and NIST/USA.

4.1 Conducted Emissions from Power Ports

Description Manufacturer	Model No.	Serial No.	Calibrated Date	Calibrated Until
50 ohm terminal resistance LYNICS	0900510	E1-01-299	2024/1/3	2025/1/2
		E1-011286	2023/9/21	2024/9/20
EMI Test Receiver R&S	ESCI	100412	2023/8/23	2024/8/22
	ESCS 30	100276	2023/4/20	2024/4/19
	ESR3	102414	2023/12/12	2024/12/11
Fixed Attenuator STI	STI02-2200-10	NO.2	2023/7/17	2024/7/16
LISN R&S	ESH2-Z5	100104	2023/12/12	2024/12/11
	ESH3-Z5	847265/023	2023/10/23	2024/10/22
LISN Schwarzbeck	NNLK 8121	8121-731	2023/6/9	2024/6/8
		8121-00759	2023/8/21	2024/8/20
		8121-808	2023/5/2	2024/5/1
	NNLK 8129	8129229	2023/6/27	2024/6/26
RF Coaxial Cable PEWC	5D-FB	Cable-CO9-01	2023/7/17	2024/7/16
Software BVADT	Cond_V7.4.1.0	N/A	N/A	N/A

Notes:

1. The test was performed in Linkou Conduction 9.
2. The VCCI Site Registration No. C-11312.
3. Tested Date: 2024/4/8

4.2 Radiated Emissions up to 1 GHz

Description Manufacturer	Model No.	Serial No.	Calibrated Date	Calibrated Until
ADT. Tower	AT100	0205	N/A	N/A
ADT. Turn Table	TT100	0205	N/A	N/A
Bi_Log Antenna Schwarzbeck	VULB 9168	9168-303	2023/10/17	2024/10/16
Coupling / Decoupling Network Schwarzbeck	CDNE-M2	00097	2023/5/25	2024/5/24
	CDNE-M3	00091	2023/5/25	2024/5/24
EMI Test Receiver R&S	ESCS 30	100292	2023/9/7	2024/9/6
Fixed Attenuator Mini-Circuits	UNAT-5+	PAD-ST2-01	2023/10/20	2024/10/19
MXE EMI Receiver Agilent	N9038A	MY50010158	2023/10/11	2024/10/10
Preamplifier Agilent	8447D	2944A11062	2024/2/7	2025/2/6
Preamplifier HP	8447D	2944A08313	2024/2/7	2025/2/6
RF Coaxial Cable Pacific	8D-FB	Cable-ST2-01	2023/11/7	2024/11/6
Software BVADT	Radiated_V8.8.09	N/A	N/A	N/A

Notes:

1. The test was performed in Linkou Open Site2 , The test site validated date: 2023/7/15 (NSA)
2. The VCCI Site Registration No. R-10237.
3. Tested Date: 2024/4/3

4.3 Radiated Emissions above 1 GHz

Description Manufacturer	Model No.	Serial No.	Calibrated Date	Calibrated Until
Fix tool for Boresight antenna tower BV	BAF-01	4	N/A	N/A
Fixed Attenuator Mini-Circuits	BW-K3-2W44+	PAD-CH7-03	2023/7/6	2024/7/5
	BW-N4W5+	PAD-CH7-02	2023/7/6	2024/7/5
Horn Antenna EMCO	3115	9312-4192	2023/11/12	2024/11/11
Horn Antenna ETS-Lindgren	3117-PA	00215857	2023/11/12	2024/11/11
Horn Antenna Schwarzbeck	BBHA-9170	BBHA9170190	2023/11/12	2024/11/11
MXA Signal Analyzer Keysight	N9020B	MY60110438	2023/11/28	2024/11/27
		MY60112260	2023/5/24	2024/5/23
Notch Filter Micro-Tronics	BRC50703-01	010	2023/5/25	2024/5/24
	BRM17690	005	2023/5/25	2024/5/24
Preamplifier EMCI	EMC0126545 EMC184045B	980076	2024/2/15	2025/2/14
		980175	2023/9/2	2024/9/1
		980235	2024/2/15	2025/2/14
Preamplifier HP	8449B	3008A01292	2024/2/15	2025/2/14
PSA Spectrum Analyzer Agilent	E4446A	MY51100009	2023/6/21	2024/6/20
RF Coaxial Cable EMEC	EM102-KMKM	01	2023/7/6	2024/7/5
RF Coaxial Cable HUBER+SUHNER	SF-102	Cable-CH7(3m)-02	2023/7/6	2024/7/5
Software BVADT	Radiated_V8.8.09	N/A	N/A	N/A
Turn Table & Tower Max Full	MF7802	MF780208103	N/A	N/A

Notes:

1. The test was performed in Linkou 966 Chamber 2 (CH 7).
2. The VCCI Site Registration No. G-10039.
3. Tested Date: 2024/4/3

4.4 Harmonic Current Measurement

Description Manufacturer	Model No.	Serial No.	Calibrated Date	Calibrated Until
Harmonics and Flicker TESEQ	NSG1007 / NSG2196 / NSG2197	1323A03998	2023/11/27	2024/11/26
Software	CTSMXL 2 V 2.26	N/A	N/A	N/A

Notes:

1. The test was performed in Linkou EMS Room No.02.
2. Tested Date: 2024/4/9

4.5 Voltage Fluctuations and Flicker Measurement

Refer to section 4.4 to get information of the instruments.

4.6 Electrostatic Discharges (ESD)

Description Manufacturer	Model No.	Serial No.	Calibrated Date	Calibrated Until
Electronic Discharge Simulator Noiseken	ESS-2000	ESS0382041	2023/10/13	2024/10/12
Electrostatic Analog Tester TESEQ	NSG 438	1875	2023/11/10	2024/11/9
ESD Generator EM TEST	Dito	V0701102114	2023/11/7	2024/11/6
	Dito//DM-150/330//DM- 150/330-rfci	P1315117252/P1317117852	2023/7/6	2024/7/5
ESD Simulator TESEQ	NSG 438	1364	2023/11/10	2024/11/9

Notes:

1. The test was performed in Linkou ESD Room No.03.
2. Tested Date: 2024/4/11

4.7 Radio Frequency Electromagnetic Field (RS)

Description Manufacturer	Model No.	Serial No.	Calibrated Date	Calibrated Until
Audio analyzer R&S	UPV	104934	2023/8/7	2024/8/6
Band Pass Filter B&K	WH3278	N/A	2023/11/20	2024/11/19
CHANCE MOST Full Anechoic Chamber (9x5x3m)	Chance Most	RS-002	2024/1/22	2025/1/21
Controller Amplifier Research	SC1000M3	305910	N/A	N/A
High Gain Horn Antenna Amplifier Research	AT4010	0329800	N/A	N/A
Isotropic EM Field Probe+EM Field Meter Wavecontrol	WPF18+SMP2	21WP090492+21SN1691	2023/12/14	2024/12/13
Log Periodic Antenna Amplifier Research	AT6080	0329465	N/A	N/A
Power Amplifier Amplifier Research	35S4G8AM4	0326094	N/A	N/A
Power Amplifier BONN	BSA 0125-800	1912556	N/A	N/A
Power Sensor Boonton	51011-EMC	32807	2023/5/31	2024/5/30
		32832	2023/5/31	2024/5/30
Pressure-field Microphone B&K	4192	3190854	2023/12/12	2024/12/11
		3190855	2023/12/12	2024/12/11
PSG Analog Signal Generator Agilent	E8257D	MY48050465	2023/6/26	2024/6/25
RF Power Amplifier BONN	BLMA 1060-150	2214325C-02	N/A	N/A
	BLWA 0810-250	2214325A-01	N/A	N/A
RF Power Meter Boonton	4232A	94901	2023/5/31	2024/5/30
Software BVADT	ABMS_Audio V7.4.10	N/A	N/A	N/A
Software BVADT	RS_V7.6.14	N/A	N/A	N/A
Stacked Log Periodic Antenna Schwarzbeck	STLP 9149	9149-260	N/A	N/A
Two channel microphone conditioning amplifier B&K	2690 OS2	3001996	2023/11/20	2024/11/19
Wireless Connectivity Tester R&S	CMW270	101075	2023/4/28	2024/4/27

Notes:

1. The test was performed in Linkou RS Room No.02.
2. Tested Date: 2024/3/15

4.8 Fast Transients Common Mode (EFT)

Description Manufacturer	Model No.	Serial No.	Calibrated Date	Calibrated Until
Capacitive Coupling clamp EMC PARTNER	CN-EFT1000	352	2023/6/5	2024/6/4
Surge & EFT Generators TESEQ	NSG 3060	1572	2023/4/18	2024/4/17

Notes:

1. The test was performed in Linkou EMS Room No.02.
2. Tested Date: 2024/4/2

4.9 Surges

Description Manufacturer	Model No.	Serial No.	Calibrated Date	Calibrated Until
CDN for Unshielded Unsymmetrical Signal & Data Lines TESEQ	CDN117	40144	2023/8/29	2024/8/28
Coupling / Decoupling Network TESEQ	CDN 118-T8	40386	2023/8/28	2024/8/27
	CDN HSS-2	41009	2023/4/18	2024/4/17
Surge & EFT Generators TESEQ	NSG 3060	1572	2023/4/18	2024/4/17

Notes:

1. The test was performed in Linkou EMS Room No.02.
2. Tested Date: 2024/3/15

4.10 Radio Frequency Common Mode (CS)

Description Manufacturer	Model No.	Serial No.	Calibrated Date	Calibrated Until
Audio analyzer R&S	UPV	104934	2023/8/7	2024/8/6
Band Pass Filter B&K	WH3278	N/A	2023/6/8	2024/6/7
CDN Calibration Kit TESEQ	CDN T8S	29459	2024/2/19	2025/2/18
Coupling / Decoupling Network EM TEST	CDN M1/32A	306508	2024/2/19	2025/2/18
Coupling / Decoupling Network FCC	FCC-801-M2-16A	01047	2024/2/19	2025/2/18
	FCC-801-M5-50A	100018	2024/1/16	2025/1/15
Coupling / Decoupling Network TESEQ	CDN M232	37702	2024/2/19	2025/2/18
	CDN M332	41256	2024/2/19	2025/2/18
		41258	2024/2/19	2025/2/18
	CDN M432S	56519	2024/2/19	2025/2/18
	CDN S200	53490	2024/2/19	2025/2/18
	CDN S400	52115	2024/2/19	2025/2/18
	CDN S751A	56435	2024/2/19	2025/2/18
		56436	2024/2/19	2025/2/18
	CDN ST08A	56525	2024/2/19	2025/2/18
		56527	2024/2/19	2025/2/18
CDN T2A-10	54942	2024/2/19	2025/2/18	



Description Manufacturer	Model No.	Serial No.	Calibrated Date	Calibrated Until
	CDN T8-10	40376	2024/2/19	2025/2/18
	CDN T8-230	56641	2023/9/28	2024/9/27
		56642	2023/9/28	2024/9/27
	CDN T400A	49918	2024/2/19	2025/2/18
	CDN T800	34428	2024/2/19	2025/2/18
Current Clamp FCC	F-120-9A	361	2023/8/23	2024/8/22
FCC EM Injection Clamp FCC	F-203I-23mm	455	N/A	N/A
Fixed Attenuator SGH	VFA_Z-06H20-N2-06	01	N/A	N/A
Power Amplifier BONN	BSA 0125-125	2314648	N/A	N/A
Power Sensor R&S	NRV-Z5	837878/039	2023/10/16	2024/10/15
Pressure-field Microphone B&K	4192	3190854	2023/12/12	2024/12/11
		3190855	2023/12/12	2024/12/11
RF Power Meter R&S	NRVD	837794/040	2023/10/16	2024/10/15
Signal Generator R&S	SML03	101364	2023/8/16	2024/8/15
Software BVADT	ABMS_Audio V7.4.10	N/A	N/A	N/A
Software BVADT	BVADT_CS_V7.6.6	N/A	N/A	N/A
Two channel microphone conditioning amplifier B&K	2690 A OS2	2645274	2023/6/8	2024/6/7
Wireless Connectivity Tester R&S	CMW270	101075	2023/4/28	2024/4/27

Notes:

1. The test was performed in Linkou CS Room No.1.
2. Tested Date: 2024/4/9

5 Limits of Test Items

5.1 Conducted Emissions from Power Ports

Frequency (MHz)	AC or DC power ports
	Quasi-peak, (dBuV)
0.15 - 0.5	99
0.5 - 30	93

Notes: The lower limit shall apply at the transition frequencies.

5.2 Radiated Emissions up to 1 GHz

Frequency (MHz)	Quasi-peak (dBuV/m)	
	at 3m	at 10m
30 - 230	50	40
230 - 1000	57	47

- Notes:
1. The lower limit shall apply at the transition frequencies.
 2. Emission level (dBuV/m) = 20 log Emission level (uV/m).
 3. All emanations from a digital device or system, including any network of conductors and apparatus connected thereto, shall not exceed the level of field strengths specified above.

5.3 Radiated Emissions above 1 GHz

Frequency (GHz)	dBuV/m (at 3m)	
	Average	Peak
1 - 3	56	76
3 - 6	60	80

- Notes:
1. The lower limit shall apply at the transition frequencies.
 2. Emission level (dBuV/m) = 20 log Emission level (uV/m).

Frequency Range of Radiated Measurement (For unintentional radiators)

Highest internal frequency (F_x) (MHz)	Highest measurement frequency (F_m) (GHz)
$F_x \leq 108 \text{ MHz}$	1
$108 \text{ MHz} < F_x \leq 500 \text{ MHz}$	2
$500 \text{ MHz} < F_x \leq 1 \text{ GHz}$	5
$F_x > 1 \text{ GHz}$	$5 \times F_x$ up to a maximum of 6 GHz

F_x is the highest fundamental frequency generated and/or used in the ITE or digital apparatus under test.

5.4 Harmonic Current Measurement

Limits for Class A equipment		Limits for Class D equipment		
Harmonic Order n	Max. permissible harmonics current A	Harmonic Order n	Max. permissible harmonics current per watt mA/W	Max. permissible harmonics current A
Odd harmonics		Odd Harmonics only		
3	2.30	3	3.4	2.30
5	1.14	5	1.9	1.14
7	0.77	7	1.0	0.77
9	0.40	9	0.5	0.40
11	0.33	11	0.35	0.33
13	0.21	13	0.30	0.21
$15 \leq n \leq 39$	$0.15 \times 15/n$	$15 \leq n \leq 39$	$3.85/n$	$0.15 \times 15/n$
Even harmonics				
2	1.08			
4	0.43			
6	0.30			
$8 \leq n \leq 40$	$0.23 \times 8/n$			

Notes: 1. Class A and Class D are classified according to section 5 of EN 61000-3-2.

2. According to section 7 of EN 61000-3-2, the above limits for all equipment except for lighting equipment having an active input power > 75 W and no limits apply for equipment with an active input power up to and including 75 W.

Classification of equipment

Class A	Class B	Class C	Class D
Balanced three-phase equipment; Household appliances excluding equipment as Class D; Tools excluding portable tools; Dimmers for incandescent lamps; Audio equipment; Equipment not specified in one of the three other classes.	Portable tools; Arc welding equipment which is not professional equipment.	Lighting equipment.	Equipment having a specified power less than or equal to 600 W of the following types: Personal computers and personal computer monitors; Television receivers; Refrigerators and freezers having one or more variable-speed drives to control compressor motor(s).

5.5 Voltage Fluctuations and Flicker Measurement

Test Item	Limit	Note
P_{st}	1.0	P_{st} means short-term flicker indicator.
P_{lt}	0.65	P_{lt} means long-term flicker indicator.
T_{dt} (ms)	500	T_{dt} means maximum time that $d(t)$ exceeds 3.3 %.
d_c (%)	3.3%	d_c means relative steady-state voltage change
d_{max} (%)		d_{max} means maximum relative voltage change. Control Method of Equipment (see below)
	4%	■ - without additional conditions
	6%	□ - switched manually, or - switched automatically more frequently than twice per day, and also has either a delayed restart (the delay not less than a few tens of seconds), or manual restart, after a power supply interruption
	7%	□ - attended whilst in use (for example: hair dryers, vacuum cleaners, kitchen equipment such as mixers, garden equipment such as lawn mowers, portable tools such as electric drills), or switched on automatically, or - is intended to be switched on manually, no more than twice per day, and also has either a delayed restart (the delay being not less than a few tens of seconds) or manual restart, after a power supply interruption.

5.6 General immunity requirements

Port	Basic Standard	Test item	Test specification	Performance criteria
Power input	IEC 61000-4-4	Fast Transients, Common Mode (EFT)	± 2 kV 5/50 ns 5 kHz, repetition frequency	A
	IEC 61000-4-5	Surge	Line to line: ± 1 kV, 42 Ω , 0,5 μ F, 1.2/50 μ s Line to earth: ± 2 kV, 42 Ω , 0,5 μ F, 1.2/50 μ s	B
	IEC 61000-4-6	Radio Frequency, Common Mode (CS)	0.15~80(MHz), 10 V, 80% AM (1 kHz)	A
Signal and communication, process measurement and control ports	IEC 61000-4-4	Fast Transients, Common Mode (EFT)	± 2 kV 5/50 ns 5 kHz, repetition frequency	A
	IEC 61000-4-6	Radio Frequency, Common Mode (CS)	0.15~80 MHz, 10 V, 80% AM (1 kHz),	A
Enclosure	IEC 61000-4-2	Electrostatic Discharge (ESD)	± 6 kV (contact) ± 8 kV (Air)	B
	IEC 61000-4-3	Radio Frequency Electromagnetic Field (RS)	80~800 MHz, 20V/m*, 80% AM (1kHz) 800~1000 MHz, 20V/m, 80% AM (1kHz) 1400~2000 MHz, 10V/m, 80% AM (1kHz) 2000~2700 MHz, 5V/m, 80% AM (1kHz) 5100~6000 MHz, 3V/m, 80% AM (1kHz)	A

*: This limit applies to equipment mounted in the passenger compartments, drivers cab or external to the rolling stock (roof, underframe). For equipment mounted in all other areas a severity level of 10 V/m may be used.

6 Test Arrangements

6.1 Conducted Emissions from Power Ports

- The EUT is placed 0.4 meters from the conducting wall of the shielded room with EUT being connected to the power mains through a line impedance stabilization network (LISN), or an Artificial Network (AN) as specified in CISPR 25 if uses in a vehicle. Other support units are connected to the power mains through another LISN and/or AN. They provide coupling impedance for the measuring instrument.
- Both lines of the power mains connected to the EUT were checked for maximum conducted interference.
- The test results of conducted emissions at mains ports are recorded of six worst margins for quasi-peak (mandatory) [and average (if necessary)] values against the limits at frequencies of interest unless the margin is 20 dB or greater.

Note: The resolution bandwidth and video bandwidth of test receiver is 9kHz for quasi-peak detection (QP) and average detection (AV) at frequency 0.15MHz-30MHz.

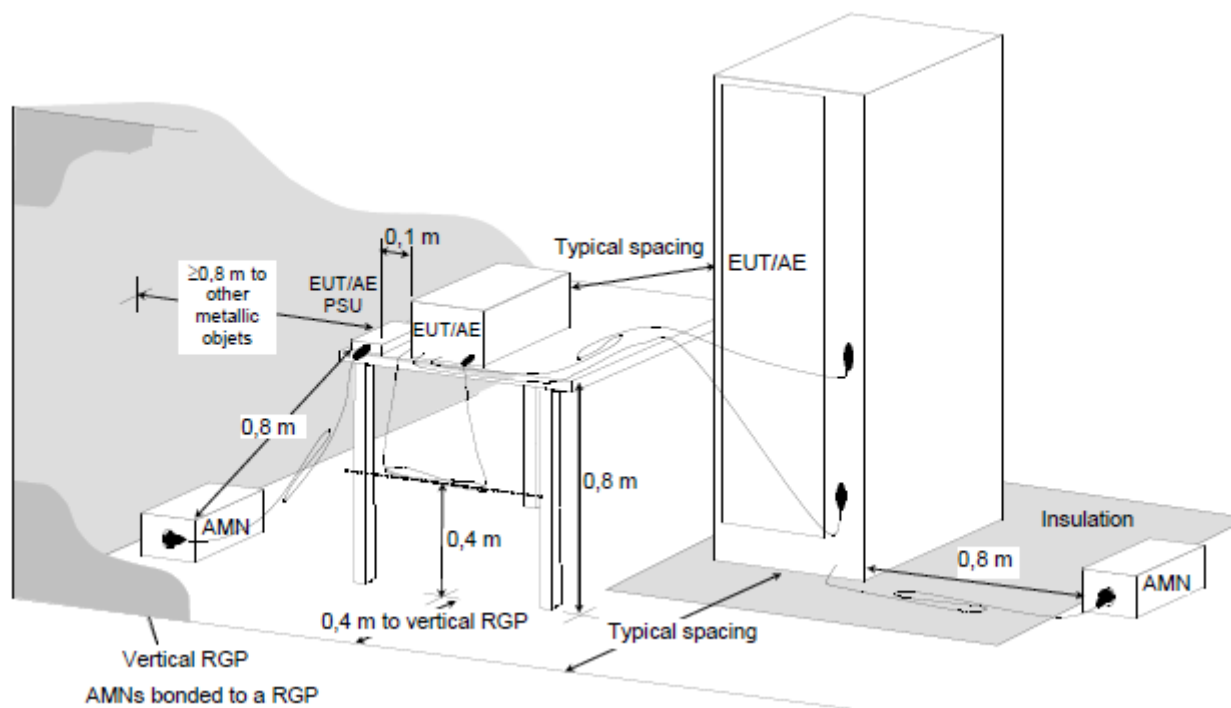

For the actual test configuration, please refer to the related Item – Photographs of the Test Configuration.

6.2 Radiated Emissions up to 1 GHz

- For the table-top EUT is placed on a 0.8 meter to the top of rotating table; for the floor standing EUT shall be insulated (by insulation of maximum thickness of 150 mm) from the horizontal reference ground plane. The rotating table is rotated 360 degrees to determine the position of the highest radiation. If the equipment requires a dedicated ground connection, this shall be provided and bonded to the RGP.
- The EUT is set 10 meters away from the interference-receiving antenna, which is mounted on the top of a variable-height antenna tower.
- The antenna is a broadband antenna, and its height is varied from one meter to four meters above the ground to determine the maximum value of the field strength. Both horizontal and vertical polarizations of the antenna are set to make the measurement.
- For each suspected emission, the EUT was arranged to its worst case and then the antenna was tuned to heights from 1 meter to 4 meters and the rotatable table was turned from 0 degrees to 360 degrees to find the maximum reading.
- The test-receiver system was set to quasi-peak detect function and specified bandwidth with maximum hold mode when the test frequency is up to 1 GHz.

Note: The resolution bandwidth and video bandwidth of test receiver/spectrum analyzer is 120kHz for quasi-peak detection (QP) at frequency up to 1GHz.

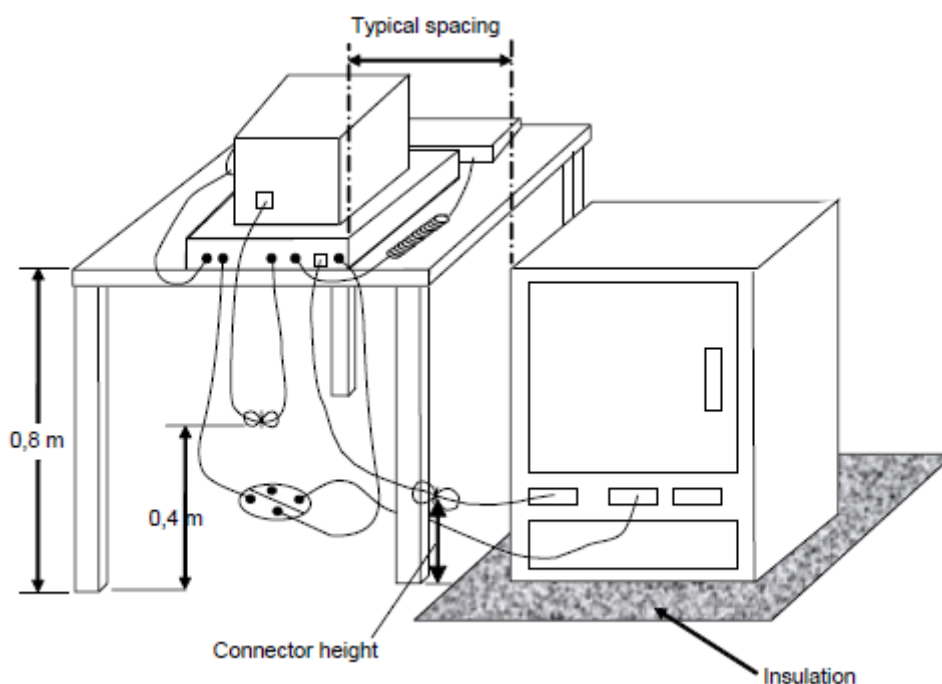

For the actual test configuration, please refer to the related Item – Photographs of the Test Configuration.

6.3 Radiated Emissions above 1 GHz

- For the table-top EUT is placed on a 0.8 meter to the top of rotating table; for the floor standing EUT shall be insulated (by insulation of maximum thickness of 150 mm) from the horizontal reference ground plane. The rotating table is rotated 360 degrees to determine the position of the highest radiation. If the equipment requires a dedicated ground connection, this shall be provided and bonded to the RGP.
- The EUT was set $d = 3$ meters away from the interference-receiving antenna, which was mounted on the top of a variable-height antenna tower.
- The height of antenna can be varied from one meter to four meters, the height of adjustment depends on the EUT height and the antenna 3dB beamwidth both, to detect the maximum value of the field strength. Both horizontal and vertical polarizations of the antenna are set to make the measurement.
- For each suspected emission, the EUT was arranged to its worst case and then the antenna was tuned to heights and the rotatable table was turned from 0 degrees to 360 degrees to find the maximum reading.
- The spectrum analyzer system was set to peak and average detects function and specified bandwidth with maximum hold mode when the test frequency is above 1 GHz.

Note: The resolution bandwidth of test receiver/spectrum analyzer is 1MHz and video bandwidth is 3MHz for Peak detection (PK) at frequency above 1GHz. The resolution bandwidth of test receiver/spectrum analyzer is 1 MHz for Average detection (AV) at frequency above 1GHz.

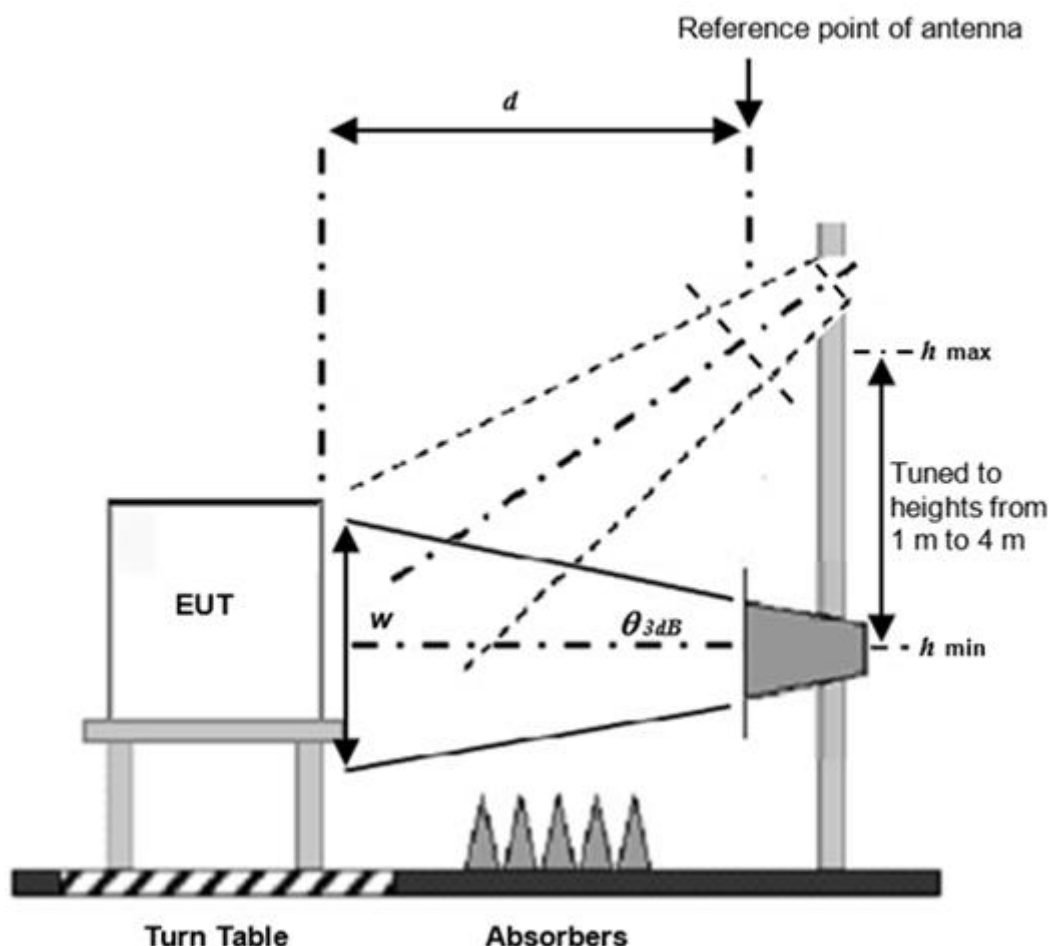

For the actual test configuration, please refer to the related item – Photographs of the Test Configuration.

6.4 Harmonic Current Measurement

- The harmonic current limits apply to line currents and not to currents in the neutral conductor. Nevertheless, for single-phase equipment, it is permissible to measure the currents in the neutral conductor instead of the currents in the line.
- The EUT is tested as presented by, and in accordance with information provided by, the manufacturer. Preliminary operation of motor drives by the manufacturer may be needed before the tests are undertaken to ensure that results correspond with normal use.
- In all configurations, the use of additional load shall not cause the total output power available to be exceeded.
- The correspondent test program of test instrument to measure the current harmonics emanated from EUT is chosen. The measure time shall be not less than the time necessary for the EUT to be exercised.

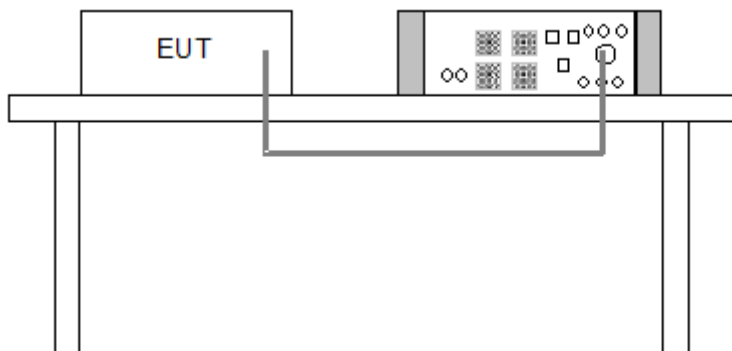

For the actual test configuration, please refer to the related Item – Photographs of the Test Configuration.

6.5 Voltage Fluctuations and Flicker Measurement

- Controls or automatic programs of the EUT shall be set to produce the most unfavourable sequence of voltage changes, using only those combinations of controls and programmes which are mentioned by the manufacturer in the instruction manual, or are otherwise likely to be used.
- Preliminary operation of motor drives may be needed before the tests to ensure that results corresponding to those of normal use are obtained.
- During the flick measurement, the measure time shall include that part of whole operation cycle in which the EUT produce the most unfavorable sequence of voltage changes. The observation period for short-term flicker indicator is 10 minutes and the observation period for long-term flicker indicator is 2 hours.

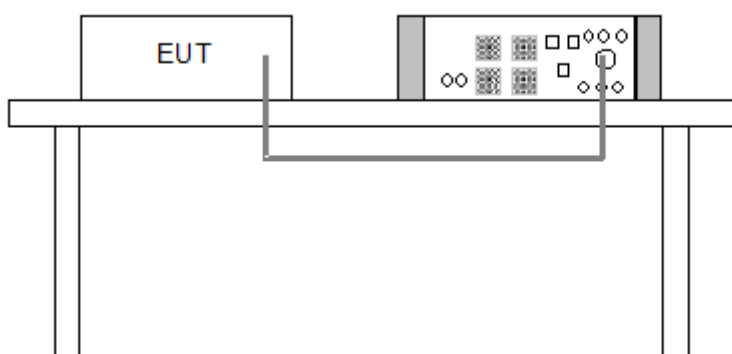

For the actual test configuration, please refer to the related Item – Photographs of the Test Configuration.

6.6 Electrostatic Discharges (ESD)

Discharge Impedance:	330 ohm / 150 pF
Number of Discharge:	Air – Direct: 10 discharges per location (each polarity) Contact – Direct & Indirect: 10 discharges per location (each polarity)
Discharge Period:	1-second minimum

The basic test procedure was in accordance with EN/IEC 61000-4-2:

- a. Electrostatic discharges were applied only to those points and surfaces of the EUT that are accessible to users during normal operation.
- b. The test was performed with at least ten single discharges on the pre-selected points in the most sensitive polarity.
- c. The time interval between two successive single discharges was at least 1 second.
- d. The ESD generator was held perpendicularly to the surface to which the discharge was applied and the return cable was at least 0.2 meters from the EUT.
- e. Contact discharges were applied to the non-insulating coating, with the pointed tip of the generator penetrating the coating and contacting the conducting substrate.
- f. Air discharges were applied with the round discharge tip of the discharge electrode approaching the EUT as fast as possible (without causing mechanical damage) to touch the EUT. After each discharge, the ESD generator was removed from the EUT and re-triggered for a new single discharge. The test was repeated until all discharges were complete.
- g. At least ten single discharges (in the most sensitive polarity) were applied to the **Horizontal Coupling Plane** at points on each side of the EUT. The ESD generator was positioned at a distance of 0.1 meters from the EUT with the discharge electrode touching the **HCP**.
- h. At least ten single discharges (in the most sensitive polarity) were applied to the center of one vertical edge of the **Vertical Coupling Plane** in sufficiently different positions that the four faces of the EUT were completely illuminated. The **VCP** (dimensions 0.5m x 0.5m) was placed vertically to and 0.1 meters from the EUT.

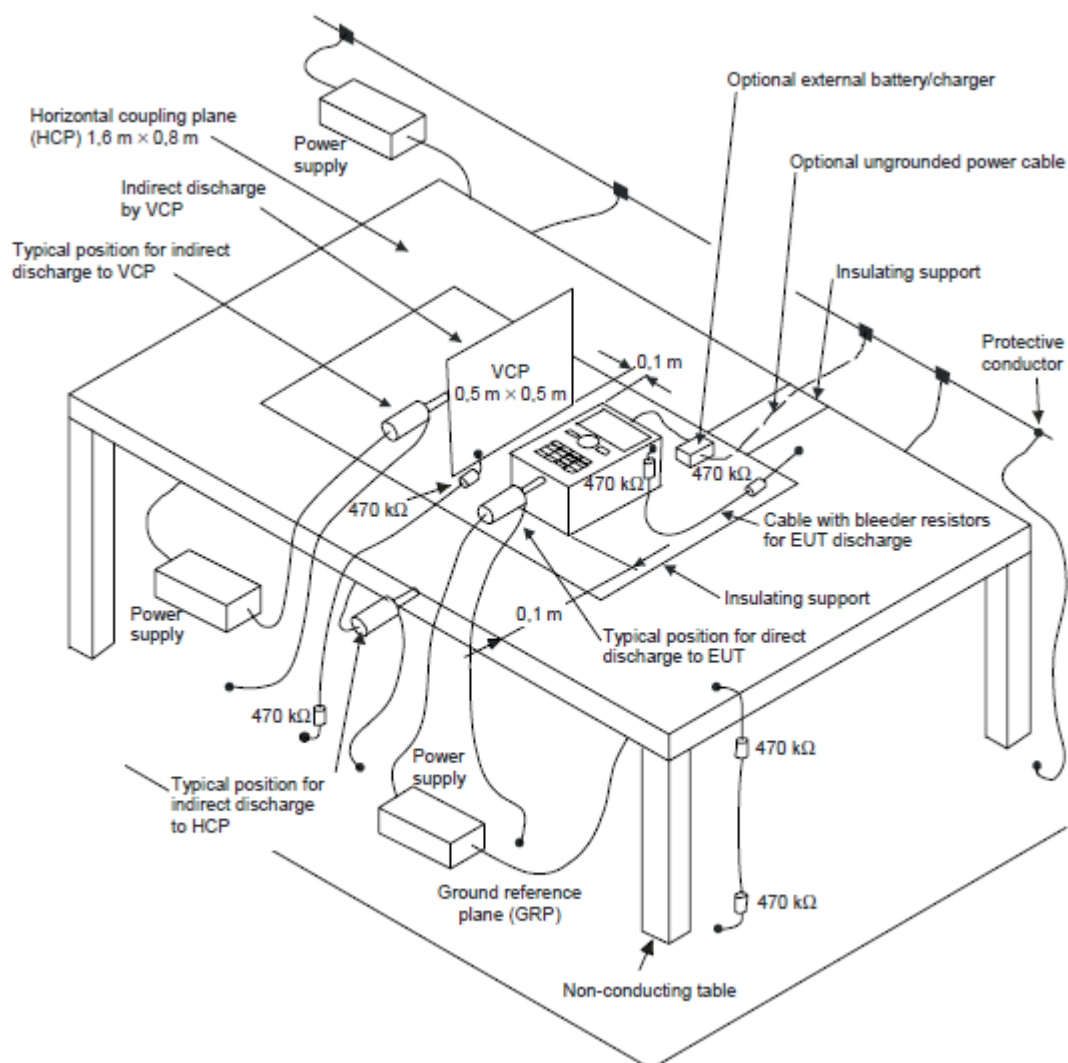

For the actual test configuration, please refer to the related item – Photographs of the Test Configuration.

NOTE:

TABLE-TOP EQUIPMENT

The configuration consisted of a wooden table 0.8 meters high standing on the **Ground Reference Plane**. The **GRP** consisted of a sheet of aluminum at least 0.25mm thick, and 2.5 meters square connected to the protective grounding system. A **Horizontal Coupling Plane** (1.6m x 0.8m) was placed on the table and attached to the **GRP** by means of a cable with 940kΩ total impedance. The equipment under test, was installed in a representative system as described in section 7 of EN/IEC 61000-4-2, and its cables were placed on the **HCP** and isolated by an insulating support of 0.5mm thickness. A distance of 1-meter minimum was provided between the EUT and the walls of the laboratory and any other metallic structure.

FLOOR-STANDING EQUIPMENT

The equipment under test was installed in a representative system as described in section 7 of IEC 61000-4-2, and its cables were isolated from the Ground Reference Plane by an insulating support of 0.1-meter thickness. The GRP consisted of a sheet of aluminum that is at least 0.25mm thick, and 2.5 meters square connected to the protective grounding system and extended at least 0.5 m.

6.7 Radio Frequency Electromagnetic Field (RS)

Modulation:	1kHz Sine Wave, 80%, AM Modulation
Frequency Step:	1 % of preceding frequency value
Dwell Time:	3 seconds

The test procedure was in accordance with EN/IEC 61000-4-3.

- The testing was performed in a modified semi-anechoic chamber.
- The frequency range shall be swept, with the signal 80% amplitude modulated with a 1kHz sine wave.
- The test was performed with the EUT exposed to both vertically and horizontally polarized fields on each of the four sides.

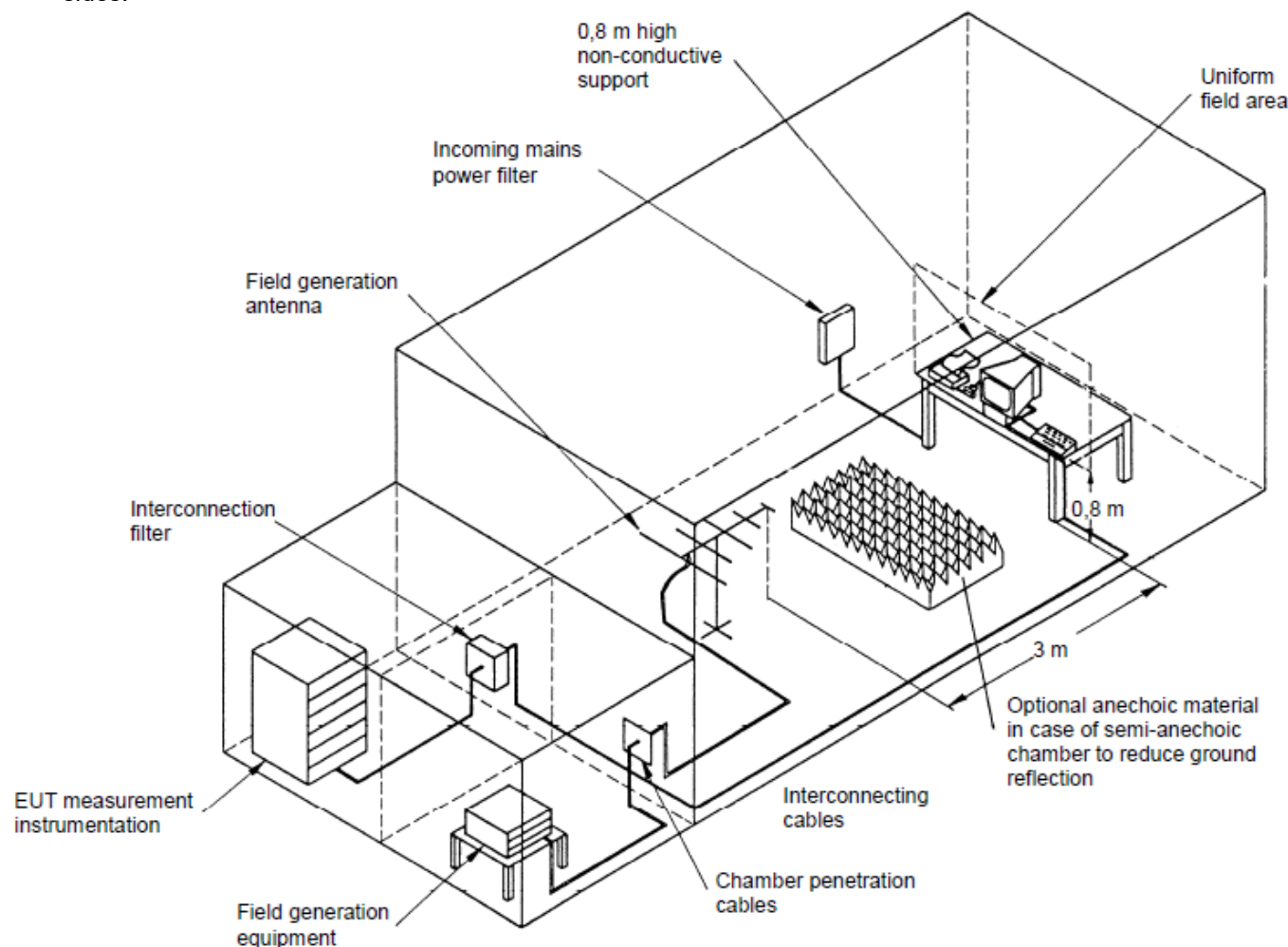

For the actual test configuration, please refer to the related item – Photographs of the Test Configuration.

NOTE:

TABLETOP EQUIPMENT

The EUT installed in a representative system as described in section 7 of EN/IEC 61000-4-3 was placed on a non-conductive table 0.8 meters in height. The system under test was connected to the power and signal wire according to relevant installation instructions.

FLOOR STANDING EQUIPMENT

The EUT installed in a representative system as described in section 7 of EN/IEC 61000-4-3 was placed on a non-conductive wood support 0.1 meters in height. The system under test was connected to the power and signal wire according to relevant installation instructions.

6.8 Fast Transients Common Mode (EFT)

Impulse Repetition Frequency:	5kHz
Impulse Wave Shape:	5/50 ns
Burst Duration:	15 ms
Burst Period:	300 ms
Test Duration:	1 min.

- Both positive and negative polarity discharges were applied.
- The distance between any coupling devices and the EUT should be 0.5 m for table-top equipment testing, and 1.0 m for floor standing equipment.
- The duration time of each test sequential was 1 minute.
- The transient/burst waveform was in accordance with EN/IEC 61000-4-4, 5/50 ns.

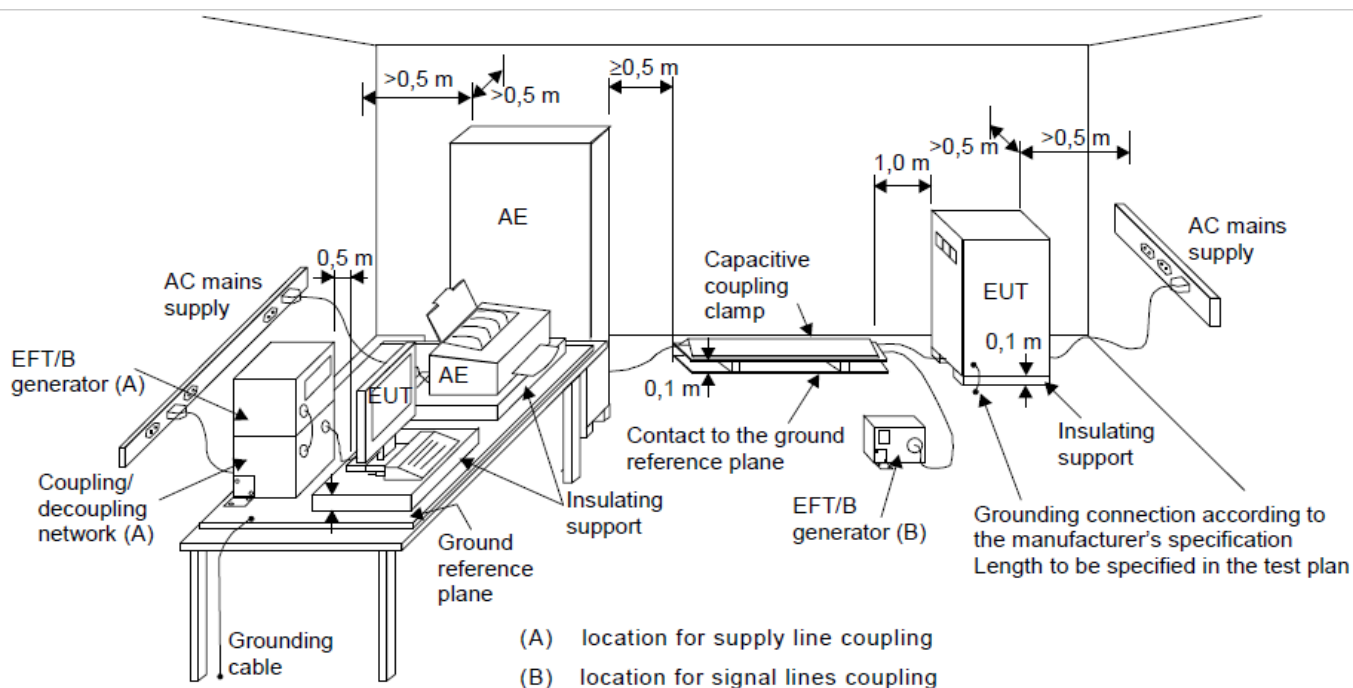

For the actual test configuration, please refer to the related item – Photographs of the Test Configuration.

6.9 Surges

Wave-Shape:	Battery referenced ports (except at the output of energy sources), auxiliary AC power input ports: 1.2/50 μ s Open Circuit Voltage 8/20 μ s Short Circuit Current
Pulse Repetition Rate:	60 sec.
Number of Tests:	5 positive and 5 negative at selected points

a. EUT Power ports:

The surge shall be applied to the EUT power supply terminals via the capacitive coupling network. Decoupling networks are required in order to avoid possible adverse effects on equipment not under test that may be powered by the same lines and to provide sufficient decoupling impedance to the surge wave. The power cord between the EUT and the coupling network shall not exceed 2 meters in length.

For double-insulated products without PE or external earth connections, the test shall be done in a similar way as for grounded products but without adding any additional external grounded connections. If there are no other possible connections to earth, line-to-ground tests may be omitted.

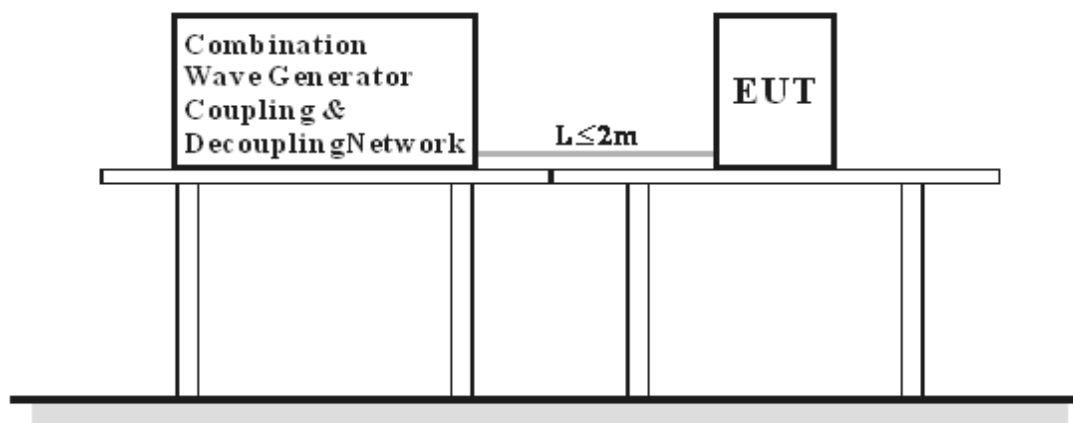

For the actual test configuration, please refer to the related item – Photographs of the Test Configuration.

6.10 Radio Frequency Common Mode (CS)

Modulation:	1kHz Sine Wave, 80%, AM Modulation
Frequency Step:	1 % of preceding frequency value
Dwell Time	3 seconds

- The EUT shall be tested within its intended operating and climatic conditions.
- An artificial hand was placed on the hand-held accessory and connected to the ground reference plane.
- One of the CDNs not used for injection was terminated with 50 ohm, providing only one return path. All other CDNs were coupled as decoupling networks.
- The frequency range shall be swept, using the signal level established during the setting process and with a disturbance signal of 80 % amplitude. The signal is modulated with a 1 kHz sine wave, pausing to adjust the RF signal level or the switch coupling devices as necessary. Where the frequency is swept incrementally, the step size shall not exceed 1 % of the preceding frequency value.
- Attempts should be made to fully exercise the EUT during testing, and to fully interrogate all exercise modes selected for susceptibility.

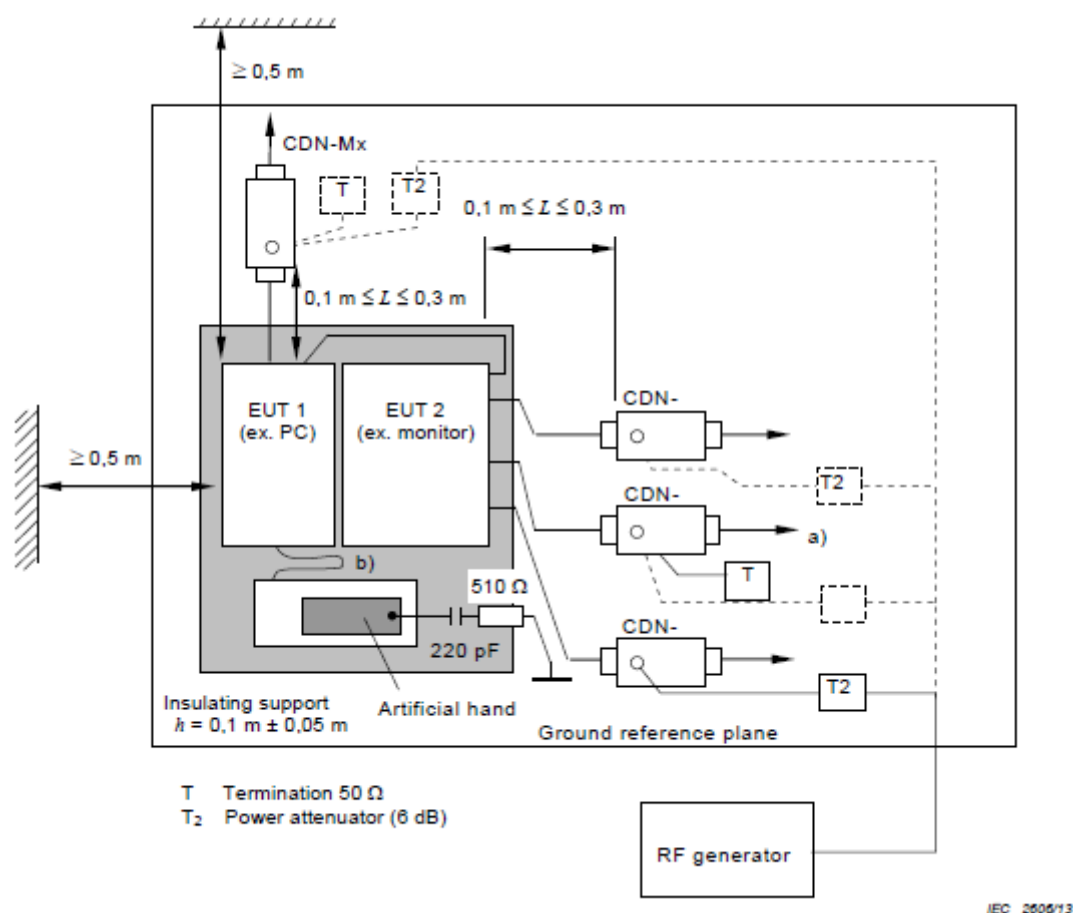

- Note:**
- The EUT clearance from any metallic obstacles shall be at least 0,5 m.
 - Interconnecting cables (≤ 1 m) belonging to the EUT shall remain on the insulating support.
- For the actual test configuration, please refer to the related item – Photographs of the Test Configuration.

7 Test Results of Test Item

7.1 Conducted Emissions from Power Ports

Mode A

Frequency Range	150 kHz ~ 30 MHz	Detector Function & Resolution Bandwidth	Quasi-Peak (QP), 9 kHz
Input Power	230 Vac, 50 Hz	Environmental Conditions	22°C, 84% RH, 1004.9 mbar
Tested by	Bob Lin		

Phase Of Power : Line (L)						
No	Frequency (MHz)	Correction Factor (dB)	Reading Value (dBuV)	Emission Level (dBuV)	Limit (dBuV)	Margin (dB)
			Q.P.	Q.P.	Q.P.	Q.P.
1	0.49325	10.24	31.64	41.88	99.00	-57.12
2	0.71519	10.26	29.51	39.77	93.00	-53.23
3	0.79610	10.27	29.58	39.85	93.00	-53.15
4	1.23072	10.30	28.92	39.22	93.00	-53.78
5	1.72098	10.33	27.03	37.36	93.00	-55.64
6	21.39100	10.81	31.92	42.73	93.00	-50.27

Remarks:

1. Q.P. and AV. are abbreviations of quasi-peak and average individually.
2. The emission levels of other frequencies were very low against the limit.
3. Margin value = Emission level – Limit value
4. Correction factor = Insertion loss + Cable loss
5. Emission Level = Correction Factor + Reading Value

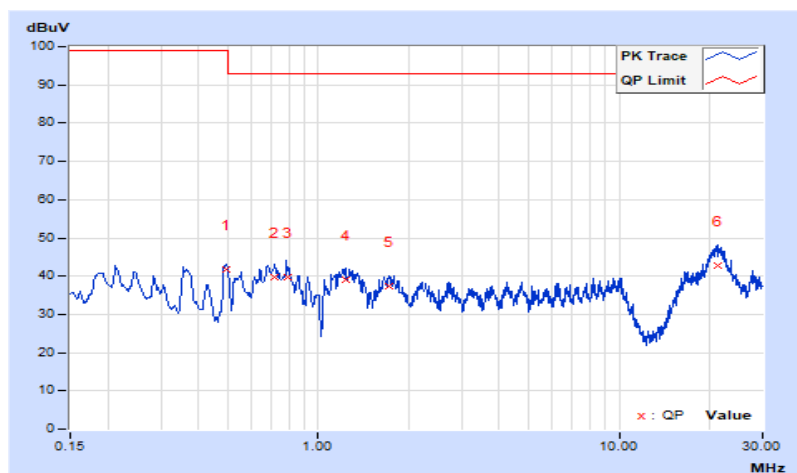

Frequency Range	150 kHz ~ 30 MHz	Detector Function & Resolution Bandwidth	Quasi-Peak (QP), 9 kHz
Input Power	230 Vac, 50 Hz	Environmental Conditions	22°C, 84% RH, 1004.9 mbar
Tested by	Bob Lin		

Phase Of Power : Neutral (N)						
No	Frequency (MHz)	Correction Factor (dB)	Reading Value (dBuV)	Emission Level (dBuV)	Limit (dBuV)	Margin (dB)
			Q.P.	Q.P.	Q.P.	Q.P.
1	0.18509	10.14	28.09	38.23	99.00	-60.77
2	0.71510	10.25	26.58	36.83	93.00	-56.17
3	1.28942	10.30	26.61	36.91	93.00	-56.09
4	4.80210	10.44	22.45	32.89	93.00	-60.11
5	8.73109	10.46	24.15	34.61	93.00	-58.39
6	21.86423	10.54	29.22	39.76	93.00	-53.24

Remarks:

1. Q.P. and AV. are abbreviations of quasi-peak and average individually.
2. The emission levels of other frequencies were very low against the limit.
3. Margin value = Emission level – Limit value
4. Correction factor = Insertion loss + Cable loss
5. Emission Level = Correction Factor + Reading Value

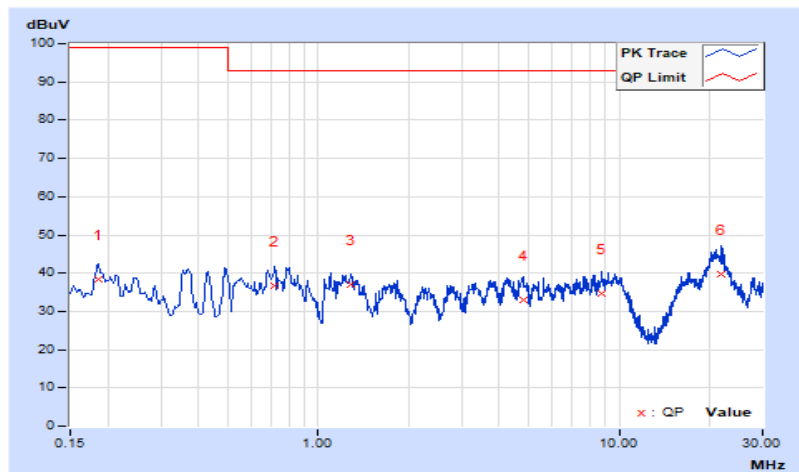

7.2 Radiated Emissions up to 1 GHz

Mode A

Frequency Range	30 MHz ~ 1 GHz	Detector Function & Resolution Bandwidth	Quasi-Peak (QP), 120 kHz
Input Power	110 Vac, 60 Hz	Environmental Conditions	24°C, 67% RH, 1001.1 mbar
Tested By	Paul Chen		

Antenna Polarity & Test Distance : Horizontal at 10 m								
No	Frequency (MHz)	Emission Level (dBuV/m)	Limit (dBuV/m)	Margin (dB)	Antenna Height (m)	Table Angle (Degree)	Raw Value (dBuV)	Correction Factor (dB/m)
1	66.11	25.99 QP	40.00	-14.01	4.00 H	340	35.72	-9.73
2	124.97	27.37 QP	40.00	-12.63	4.00 H	276	36.84	-9.47
3	148.52	30.31 QP	40.00	-9.69	4.00 H	320	37.92	-7.61
4	225.61	28.59 QP	40.00	-11.41	4.00 H	145	38.65	-10.06
5	249.99	33.69 QP	47.00	-13.31	3.86 H	177	41.80	-8.11
6	331.45	35.26 QP	47.00	-11.74	3.45 H	220	40.67	-5.41
7	499.99	33.92 QP	47.00	-13.08	2.03 H	234	36.32	-2.40
8	624.98	40.28 QP	47.00	-6.72	1.38 H	36	39.83	0.45
9	662.47	41.31 QP	47.00	-5.69	1.25 H	230	40.42	0.89
10	749.99	36.26 QP	47.00	-10.74	1.00 H	318	33.37	2.89
11	875.01	40.37 QP	47.00	-6.63	1.00 H	144	35.47	4.90
12	998.95	39.71 QP	47.00	-7.29	1.00 H	230	33.54	6.17

Remarks:

- Emission Level(dBuV/m) = Raw Value(dBuV) + Correction Factor(dB/m)
- Correction Factor(dB/m) = Antenna Factor (dB/m) + Cable Factor (dB)
– Pre-Amplifier Factor (dB)
- Margin value = Emission level – Limit value
- The other emission levels were very low against the limit.

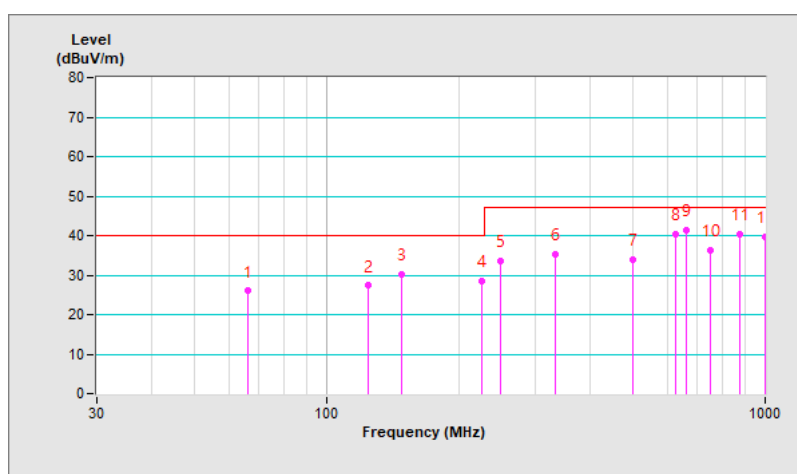

Frequency Range	30 MHz ~ 1 GHz	Detector Function & Resolution Bandwidth	Quasi-Peak (QP), 120 kHz
Input Power	110 Vac, 60 Hz	Environmental Conditions	24°C, 67% RH, 1001.1 mbar
Tested By	Paul Chen		

Antenna Polarity & Test Distance : Vertical at 10 m								
No	Frequency (MHz)	Emission Level (dBuV/m)	Limit (dBuV/m)	Margin (dB)	Antenna Height (m)	Table Angle (Degree)	Raw Value (dBuV)	Correction Factor (dB/m)
1	62.23	28.62 QP	40.00	-11.38	1.68 V	310	37.87	-9.25
2	125.00	27.95 QP	40.00	-12.05	1.00 V	247	37.42	-9.47
3	148.52	32.59 QP	40.00	-7.41	1.00 V	272	40.20	-7.61
4	227.15	27.27 QP	40.00	-12.73	1.00 V	196	37.24	-9.97
5	250.01	31.99 QP	47.00	-15.01	1.00 V	43	40.10	-8.11
6	398.28	32.42 QP	47.00	-14.58	1.00 V	228	36.71	-4.29
7	499.99	35.79 QP	47.00	-11.21	1.00 V	183	38.19	-2.40
8	624.99	39.27 QP	47.00	-7.73	3.46 V	264	38.82	0.45
9	662.51	40.08 QP	47.00	-6.92	3.07 V	199	39.20	0.88
10	750.00	37.11 QP	47.00	-9.89	2.64 V	190	34.22	2.89
11	875.00	39.81 QP	47.00	-7.19	1.94 V	250	34.91	4.90

Remarks:

1. Emission Level(dBuV/m) = Raw Value(dBuV) + Correction Factor(dB/m)
2. Correction Factor(dB/m) = Antenna Factor (dB/m) + Cable Factor (dB) – Pre-Amplifier Factor (dB)
3. Margin value = Emission level – Limit value
4. The other emission levels were very low against the limit.

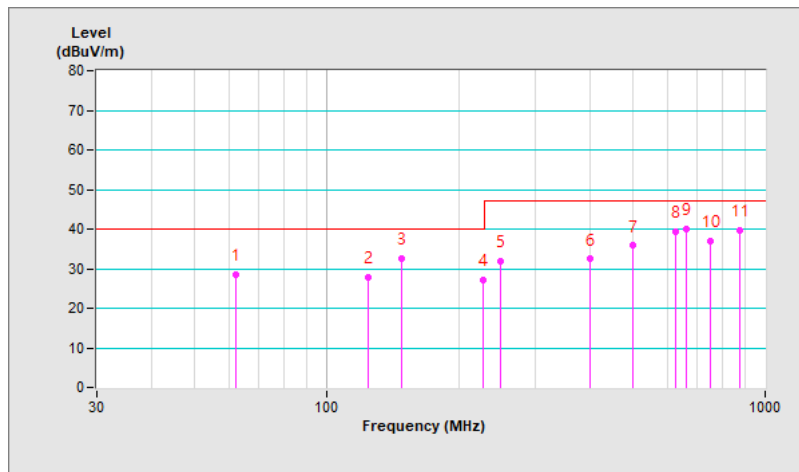

7.3 Radiated Emissions above 1 GHz

Mode A

Frequency Range	1 GHz ~ 6 GHz	Detector Function & Resolution Bandwidth	Peak (PK) / Average (AV), 1 MHz
Input Power	110 Vac, 60 Hz	Environmental Conditions	26°C, 63% RH, 1001.2 mbar
Tested By	Perry Yang		

Antenna Polarity & Test Distance : Horizontal at 3 m

No	Frequency (MHz)	Emission Level (dBuV/m)	Limit (dBuV/m)	Margin (dB)	Antenna Height (m)	Table Angle (Degree)	Raw Value (dBuV)	Correction Factor (dB/m)
1	1010.61	54.63 PK	76.00	-21.37	2.40 H	295	60.30	-5.67
2	1010.61	41.88 AV	56.00	-14.12	2.40 H	295	47.55	-5.67
3	1125.00	52.14 PK	76.00	-23.86	2.75 H	169	56.60	-4.46
4	1125.00	42.47 AV	56.00	-13.53	2.75 H	169	46.93	-4.46
5	1359.78	56.21 PK	76.00	-19.79	1.85 H	77	60.20	-3.99
6	1359.78	39.69 AV	56.00	-16.31	1.85 H	77	43.68	-3.99
7	1418.68	57.62 PK	76.00	-18.38	2.46 H	336	61.70	-4.08
8	1418.68	44.39 AV	56.00	-11.61	2.46 H	336	48.47	-4.08
9	2999.25	56.05 PK	76.00	-19.95	2.00 H	327	55.07	0.98
10	2999.25	34.77 AV	56.00	-21.23	2.00 H	327	33.79	0.98
11	4501.93	54.74 PK	80.00	-25.26	2.22 H	189	51.17	3.57
12	4501.93	36.29 AV	60.00	-23.71	2.22 H	189	32.72	3.57

Remarks:

- Emission Level(dBuV/m) = Raw Value(dBuV) + Correction Factor(dB/m)
- Correction Factor(dB/m) = Antenna Factor (dB/m) + Cable Factor (dB)
– Pre-Amplifier Factor (dB)
- Margin value = Emission level – Limit value
- The other emission levels were very low against the limit.

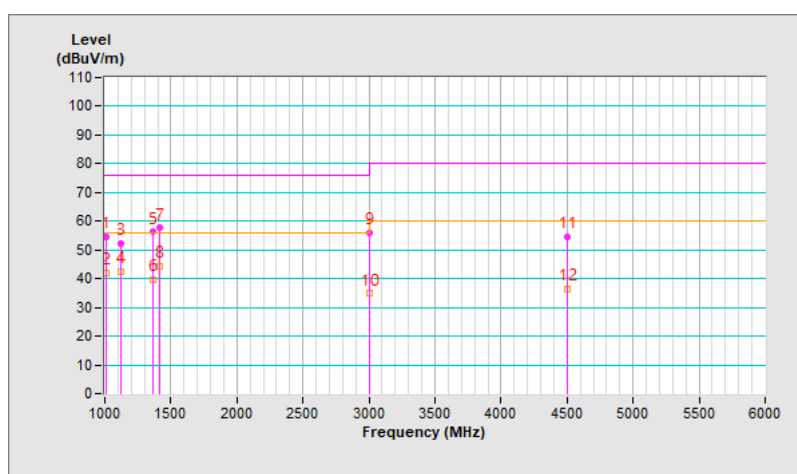

Frequency Range	1 GHz ~ 6 GHz	Detector Function & Resolution Bandwidth	Peak (PK) / Average (AV), 1 MHz
Input Power	110 Vac, 60 Hz	Environmental Conditions	26°C, 63% RH, 1000.3 mbar
Tested By	Perry Yang		

Antenna Polarity & Test Distance : Vertical at 3 m								
No	Frequency (MHz)	Emission Level (dBuV/m)	Limit (dBuV/m)	Margin (dB)	Antenna Height (m)	Table Angle (Degree)	Raw Value (dBuV)	Correction Factor (dB/m)
1	1002.94	53.41 PK	76.00	-22.59	2.03 V	186	59.16	-5.75
2	1002.94	39.37 AV	56.00	-16.63	2.03 V	186	45.12	-5.75
3	1360.30	56.29 PK	76.00	-19.71	1.90 V	302	60.28	-3.99
4	1360.30	39.87 AV	56.00	-16.13	1.90 V	302	43.86	-3.99
5	1419.16	55.28 PK	76.00	-20.72	2.14 V	323	59.35	-4.07
6	1419.16	41.74 AV	56.00	-14.26	2.14 V	323	45.81	-4.07
7	1832.86	51.86 PK	76.00	-24.14	2.61 V	199	54.10	-2.24
8	1832.86	35.96 AV	56.00	-20.04	2.61 V	199	38.20	-2.24
9	2999.37	57.17 PK	76.00	-18.83	2.60 V	350	56.19	0.98
10	2999.37	36.64 AV	56.00	-19.36	2.60 V	350	35.66	0.98
11	5564.62	52.29 PK	80.00	-27.71	1.14 V	2	46.37	5.92
12	5564.62	36.69 AV	60.00	-23.31	1.14 V	2	30.77	5.92

Remarks:

1. Emission Level(dBuV/m) = Raw Value(dBuV) + Correction Factor(dB/m)
2. Correction Factor(dB/m) = Antenna Factor (dB/m) + Cable Factor (dB) – Pre-Amplifier Factor (dB)
3. Margin value = Emission level – Limit value
4. The other emission levels were very low against the limit.

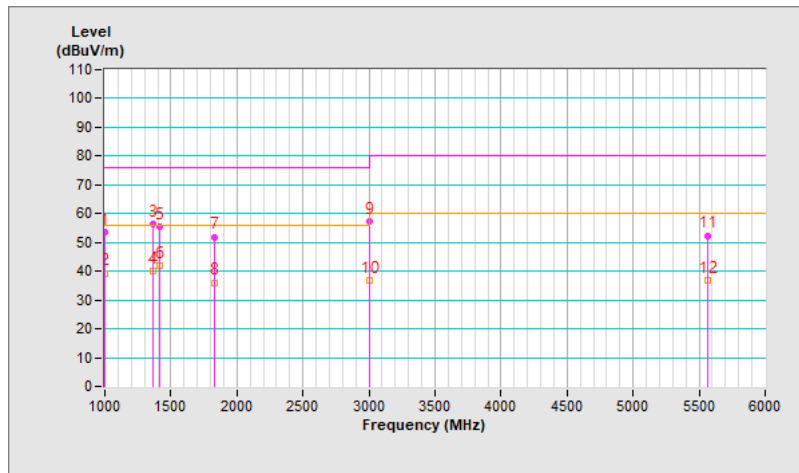

7.4 Harmonic Current Measurement

Mode A

Test Duration	5 min	Fundamental Voltage / Ampere	230.449 Vrms / 0.299 Arms
Power Consumption	60.5 W	Power Frequency	50 Hz
Power Factor	0.882	Environmental Conditions	23°C, 75% RH
Tested By	Xun Lee		

Notes:

1. Limits are not specified for equipment with a rated power of 75W or less (other than lighting equipment).
2. According to EN 61000-3-2 the manufacturer shall specify the power of the apparatus. This value shall be used for establishing limits. The specified power shall be within +/-10% of the measured power.

7.5 Voltage Fluctuations and Flicker Measurement

Mode A

Observation (Tp)	10 min		
Input Power	230 Vac, 50 Hz	Environmental Conditions	23°C, 75% RH
Tested By	Xun Lee		

Test Parameter	Measurement Value	Limit	Remarks
P_{st}	0.201	1.00	Pass
P_{lt}	0.088	0.65	Pass
T_{max} (ms)	0.000	500	Pass
d_{max} (%)	0.060	4.00	Pass
d_c (%)	0.000	3.30	Pass

Notes:

1. P_{st} means short-term flicker indicator.
2. P_{lt} means long-term flicker indicator.
3. T_{max} means accumulated time value of $d(t)$ with a deviation exceeding 3.3 %.
4. d_{max} means maximum relative voltage change.
5. d_c means maximum relative steady-state voltage change.

7.6 Electrostatic Discharges (ESD)

Mode A

For EN 50121-3-2

Input Power	AC 230V / 50Hz	Environmental conditions	23 °C, 51 % RH 1008 mbar
Tested by	Kent Wang		

Test Results of Direct Application

Discharge Level (kV)	Polarity (+/-)	Test Point	Contact Discharge	Air Discharge	Performance Criteria
2, 4, 6	+/-	4	Note 1	---	A
2	+/-	1, 3, 12	Note 1	---	A
4, 6	+/-	12	Note 2	---	B
4, 6	+/-	1, 3	Note 2, Note 3	---	B
2, 4, 8	+/-	14	---	Note 1	A
2, 4	+/-	2, 5 ~ 11, 13	---	Note 1	A
8	+/-	2, 5 ~ 11, 13	---	Note 2	B

Description of test points of direct application: Please refer to following page for representative mark only.

Test Results of Indirect Application

Discharge Level (kV)	Polarity (+/-)	Test Point	Horizontal Coupling Plane	Vertical Coupling Plane	Performance Criteria
2, 4, 6	+/-	Four Side	Note 1	Note 1	A

Description of test points of indirect application:

1. Front side 2. Rear side 3. Right side 4. Left side

Please refer to the attached page for description of test points.

Notes:

1. The EUT is operated normal during the test.
2. The image on the screen have flickered or horizontal bars during the test, it self-recover after the test.
3. The image of preview delay during the test, it self-recover after the test.

Description of test point

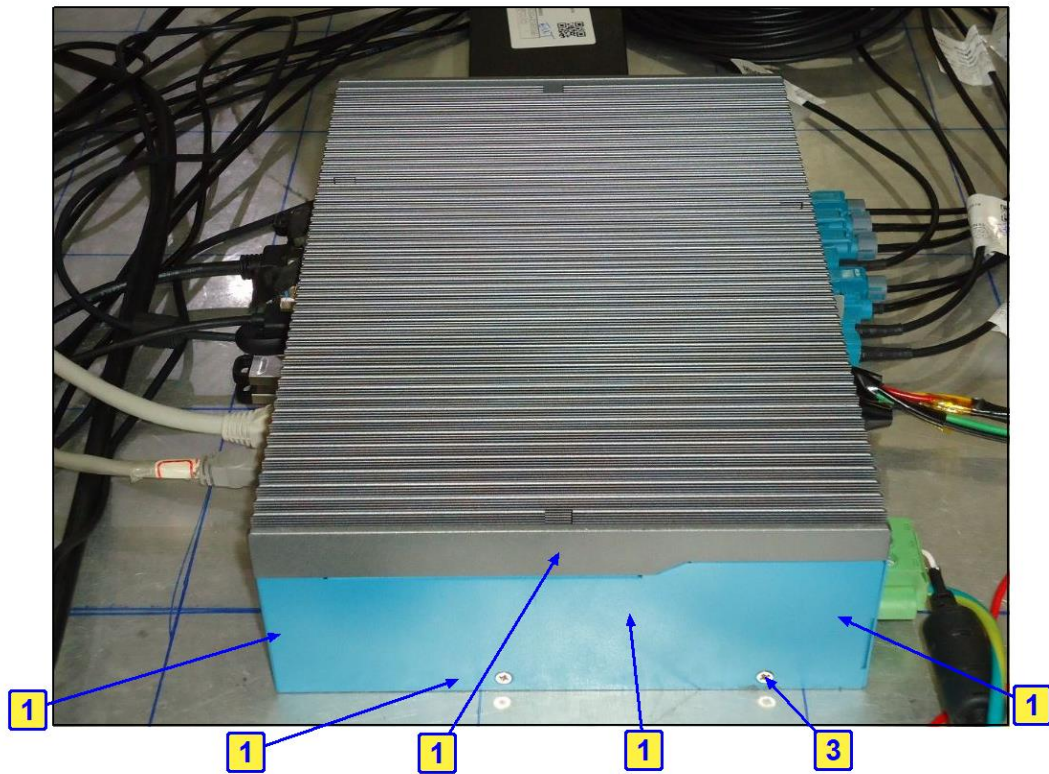
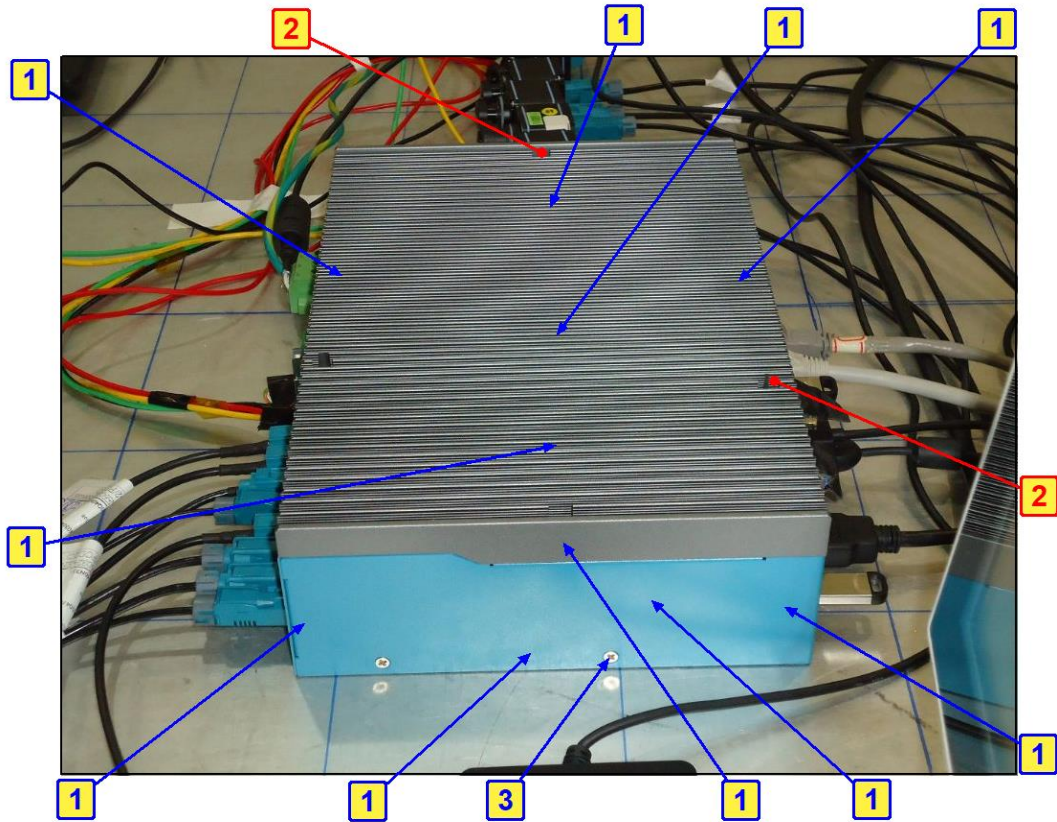

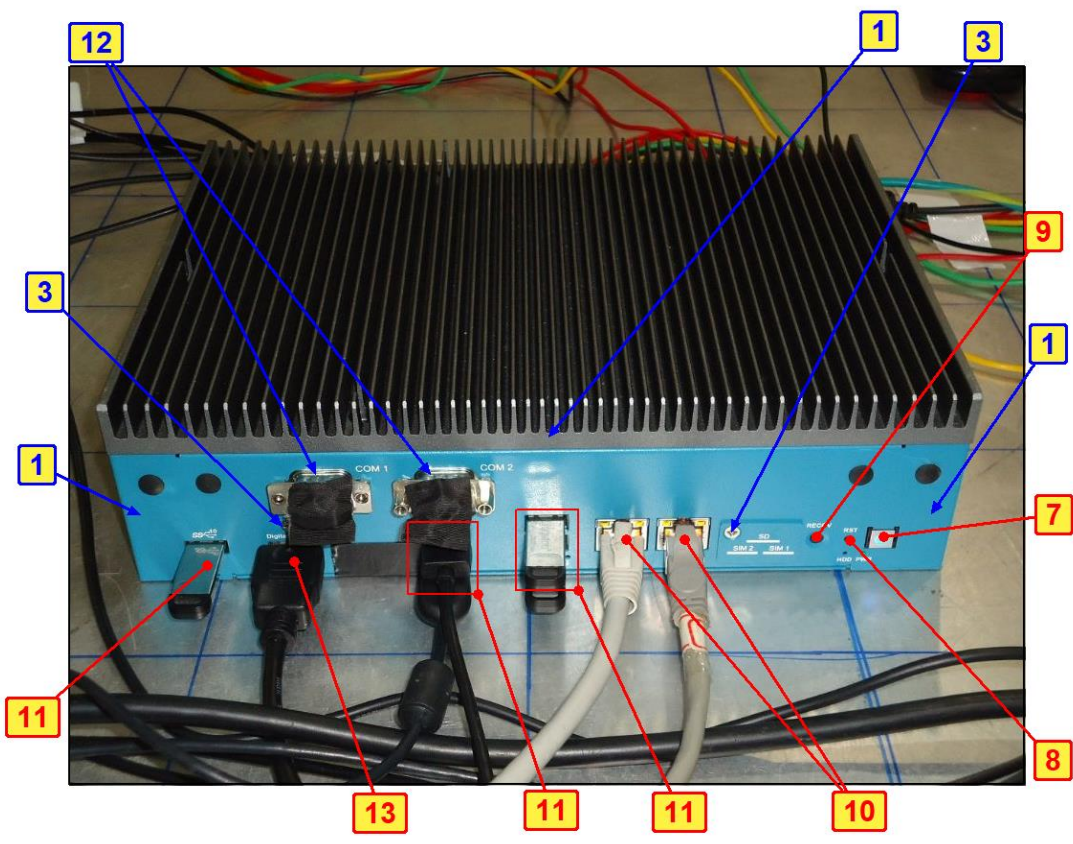
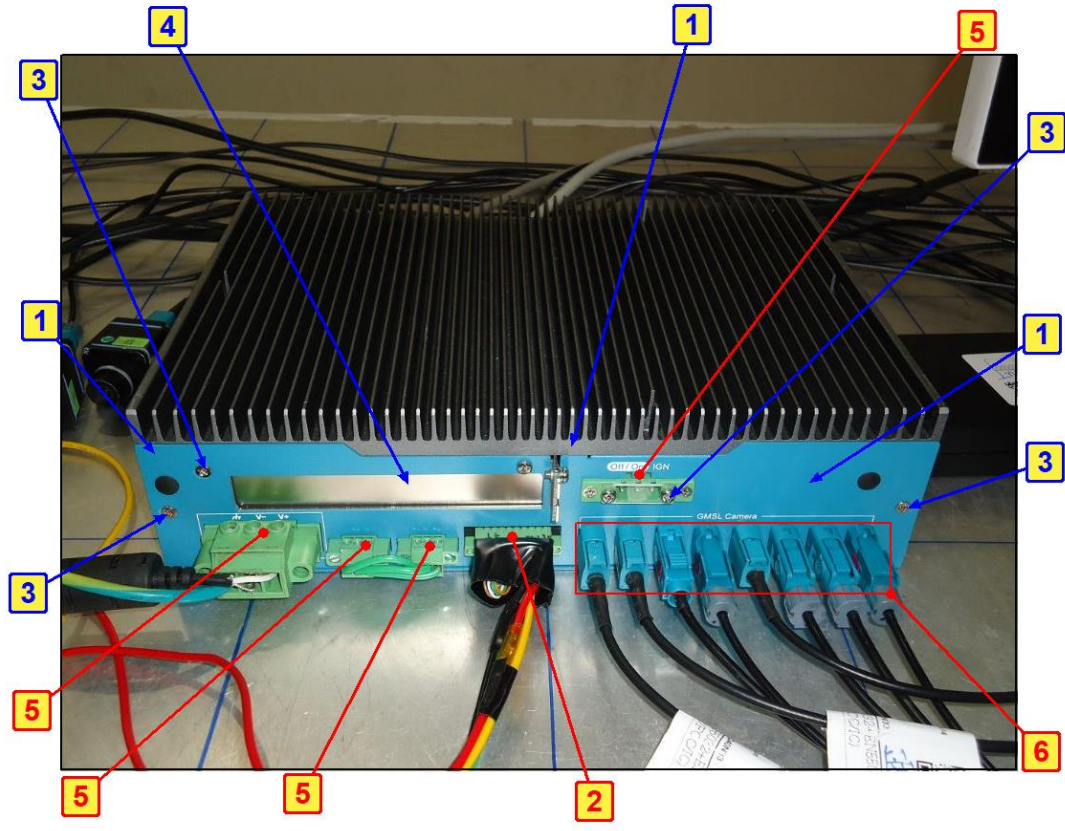



7.7 Radio Frequency Electromagnetic Field (RS)

Mode A

For EN 50121-3-2

Input Power	AC 230V / 50Hz	Environmental conditions	24 °C, 74 % RH 1009 mbar
Tested by	Joey Liu		

Frequency (MHz)	Polarity	Azimuth(°)	Applied Field Strength		Observation	Performance Criteria
			(V/m)	Modulation		
80 - 800	V&H	0, 90, 180, 270	20	80% AM (1kHz)	Note	A
800 - 1000	V&H	0, 90, 180, 270	20	80% AM (1kHz)	Note	A
1400 - 2000	V&H	0, 90, 180, 270	10	80% AM (1kHz)	Note	A
2000 - 2700	V&H	0, 90, 180, 270	5	80% AM (1kHz)	Note	A
5100 - 6000	V&H	0, 90, 180, 270	3	80% AM (1kHz)	Note	A

Note: The EUT is operated normal during the test.

7.8 Fast Transients Common Mode (EFT)

Mode A

For EN 50121-3-2

Input Power	AC 230V / 50Hz	Environmental conditions	23 °C, 75 % RH 1000 mbar
Tested by	Aga Lin		

Input AC power port				
Voltage (kV)	Test Point	Polarity (+/-)	Observation	Performance Criteria
2	L	+/-	Note	A
2	N	+/-	Note	A
2	PE	+/-	Note	A
2	L-N-PE	+/-	Note	A

Wired network and signal/ control port				
Voltage (kV)	Test Point	Polarity (+/-)	Observation	Performance Criteria
2	LAN	+/-	Note	A
2	GMSL Camera	+/-	Note	A

Note: The EUT is operated normal during the test.

7.9 Surges

Mode A

For EN 50121-3-2

Input Power	AC 230V / 50Hz	Environmental conditions	24 °C, 74 % RH 996 mbar
Tested by	Joey Liu		

Input AC power port					
Voltage (kV)	Test Point	Azimuth(°)	Polarity (+/-)	Observation	Performance Criteria
0.5,1(42 Ω+0.5μF)	L-N	0, 90, 180, 270	+/-	Note 1	A
0.5,1(42 Ω+0.5μF)	L-PE	0, 90, 180, 270	+/-	Note 1	A
0.5,1(42 Ω+0.5μF)	N-PE	0, 90, 180, 270	+/-	Note 1	A
2(42 Ω+0.5μF)	L-PE	0, 90, 180, 270	+/-	Note 2	B
2(42 Ω+0.5μF)	N-PE	0, 90, 180, 270	+/-	Note 2	B

Notes:

1. The EUT is operated normal during the test.
2. The image on the screen have flickered during the test, it self-recover after the test.

7.10 Radio Frequency Common Mode (CS)

Mode A

For EN 50121-3-2

Input Power	AC 230V / 50Hz	Environmental conditions	21 °C, 79 % RH 1010 mbar
Tested by	Xun Lee		

Input AC power port							
Frequency (MHz)	Level (V rms)	Modulation	Tested Line	Injection Method	Return Path	Observation	Performance Criteria
0.15-80	10	80% AM (1kHz)	AC	CDN-M3	CDN-M1	Note	A

Wired network and signal/ control port							
Frequency (MHz)	Level (V rms)	Modulation	Tested Line	Injection Method	Return Path	Observation	Performance Criteria
0.15-80	10	80% AM (1kHz)	LAN	CDN-ST08A	CDN-M1	Note	A
0.15-80	10	80% AM (1kHz)	GMSL Camera	EM-Clamp	CDN-M1	Note	A

Note: The EUT is operated normal during the test.

8 Pictures of Test Arrangements

8.1 Conducted Emissions from Power Ports

Mode A

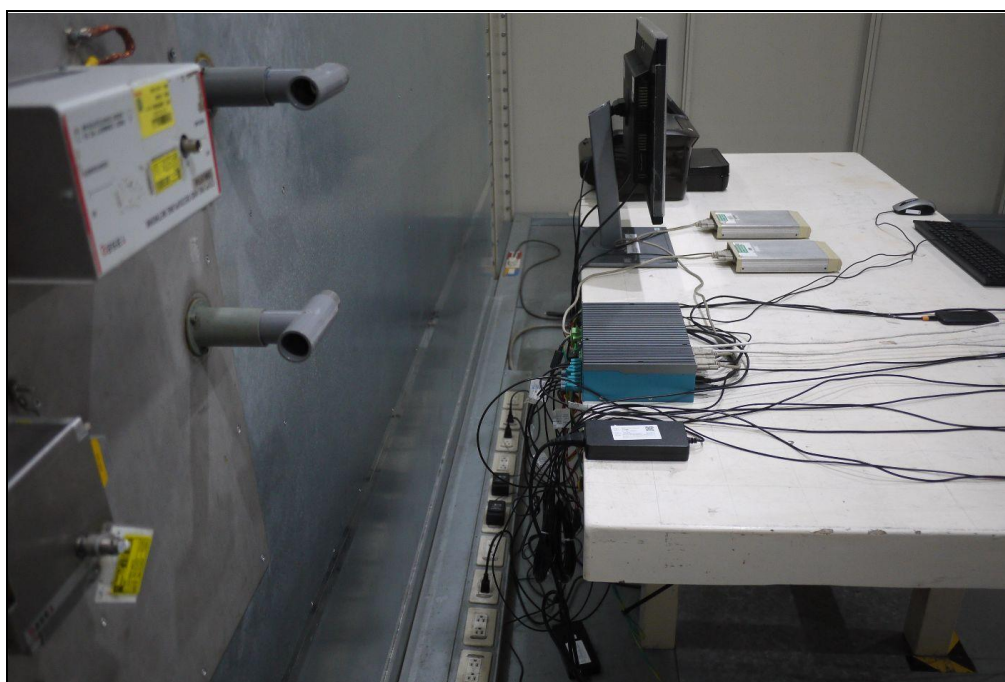
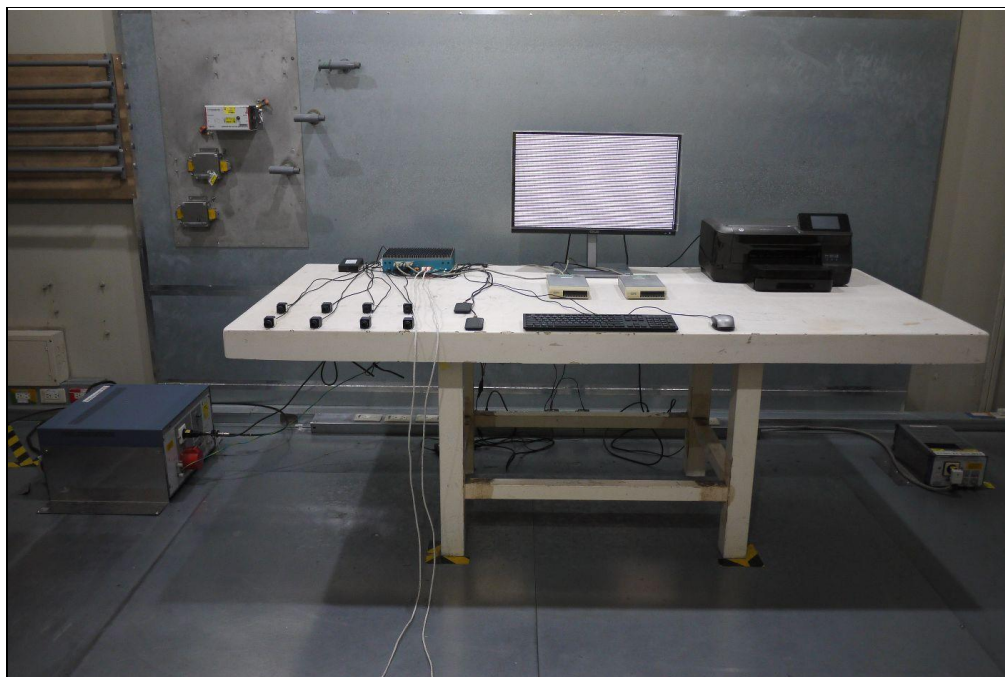

8.2 Radiated Emissions up to 1 GHz

Mode A



8.3 Radiated Emissions above 1 GHz

Mode A

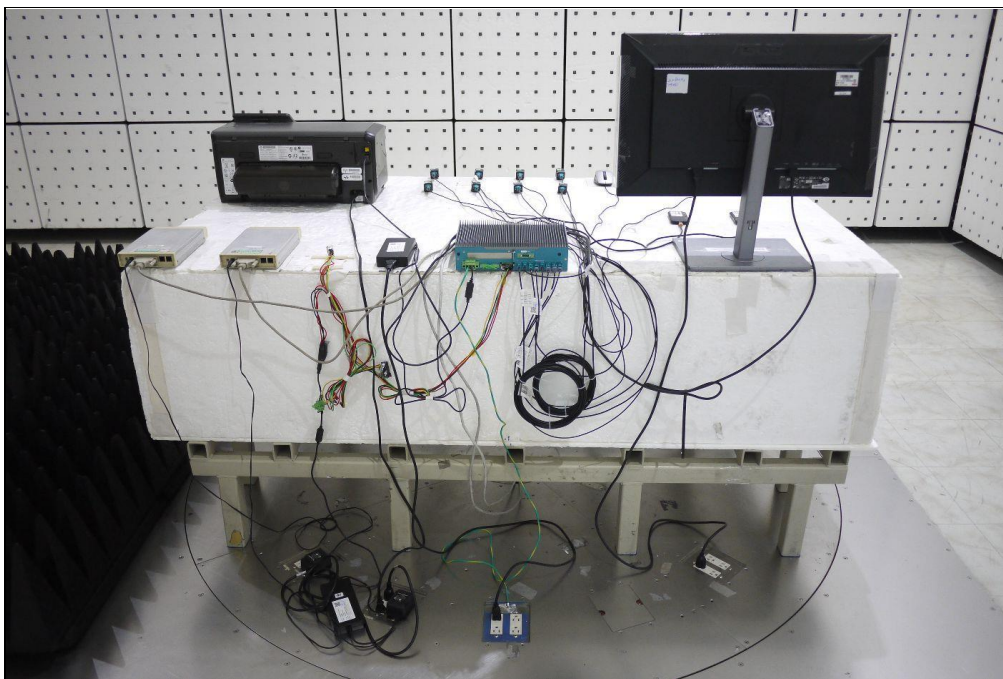

8.4 Electrostatic Discharges (ESD)

Mode A

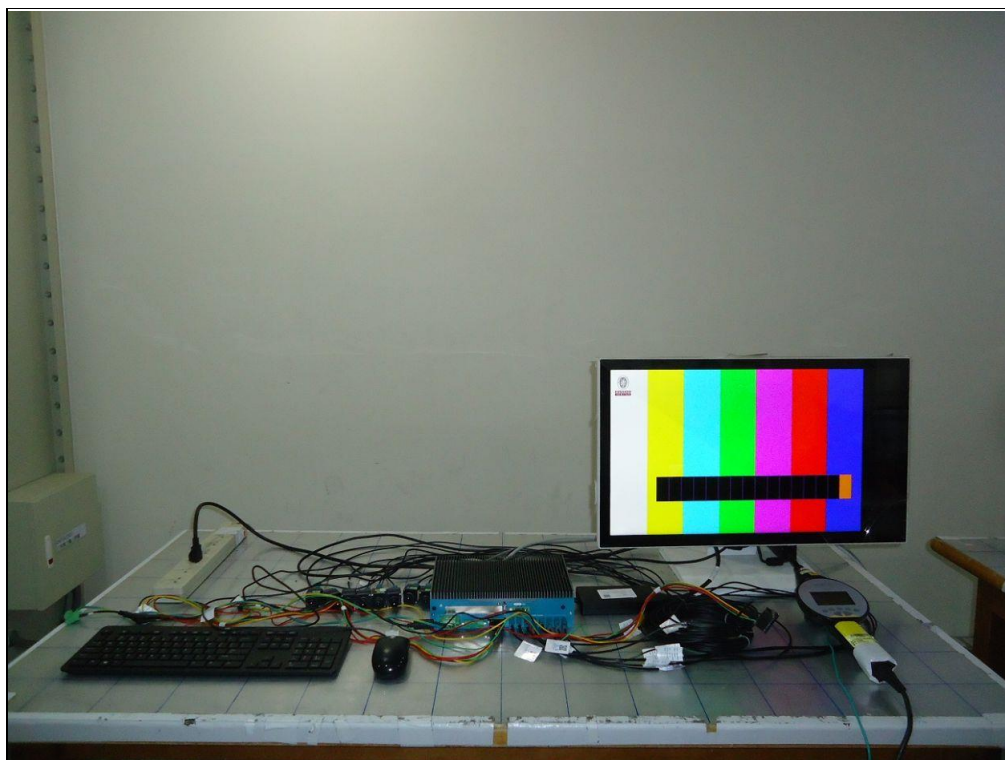

8.5 Radio Frequency Electromagnetic Field (RS)

Mode A

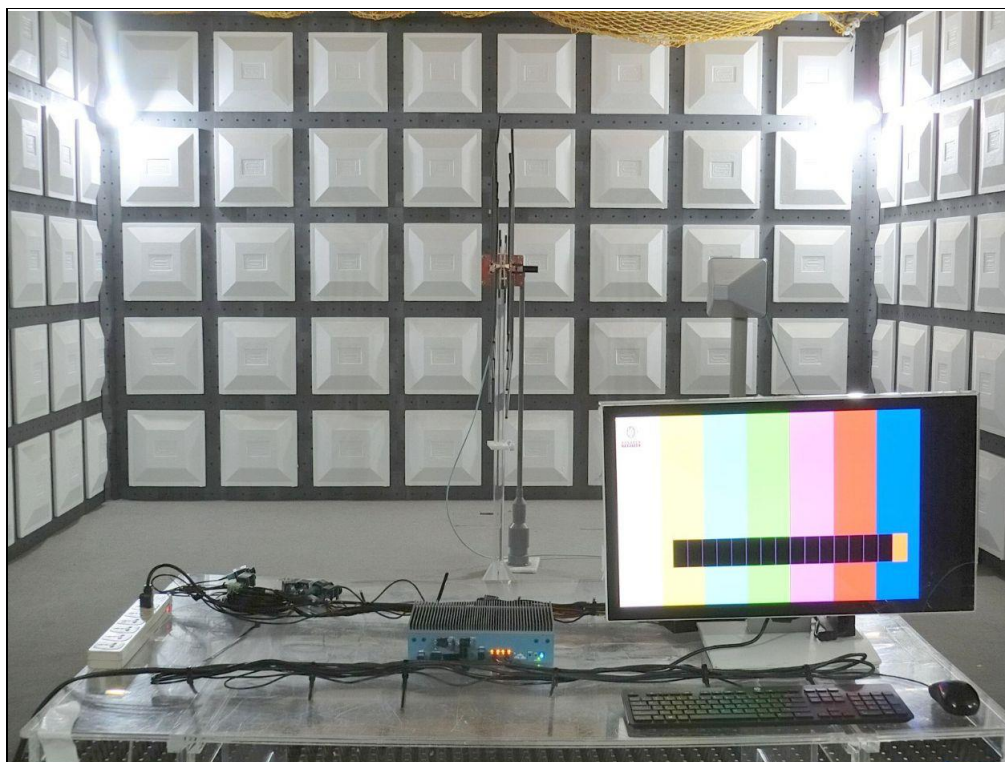

8.6 Fast Transients Common Mode (EFT)

Mode A

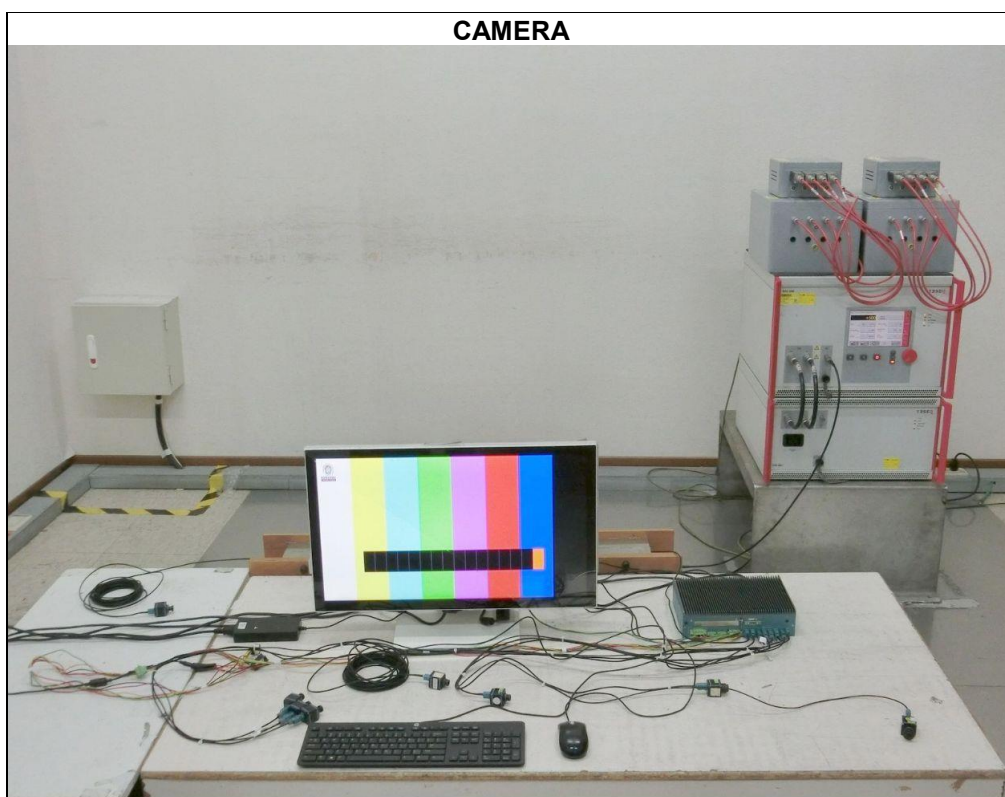
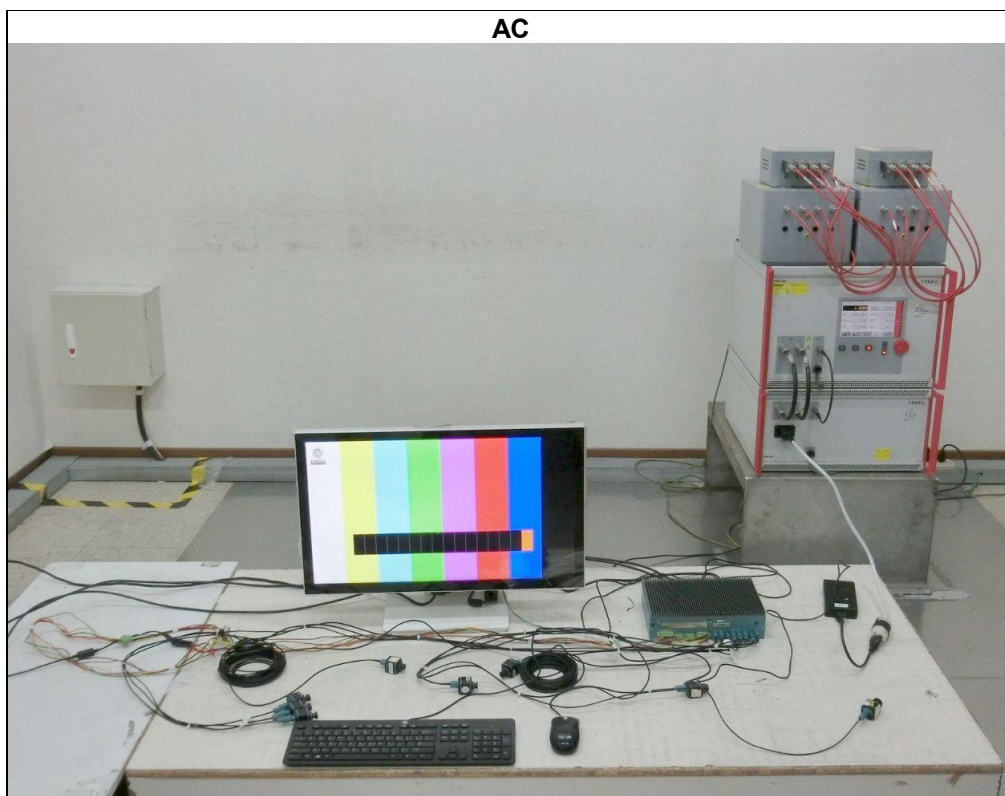

LAN

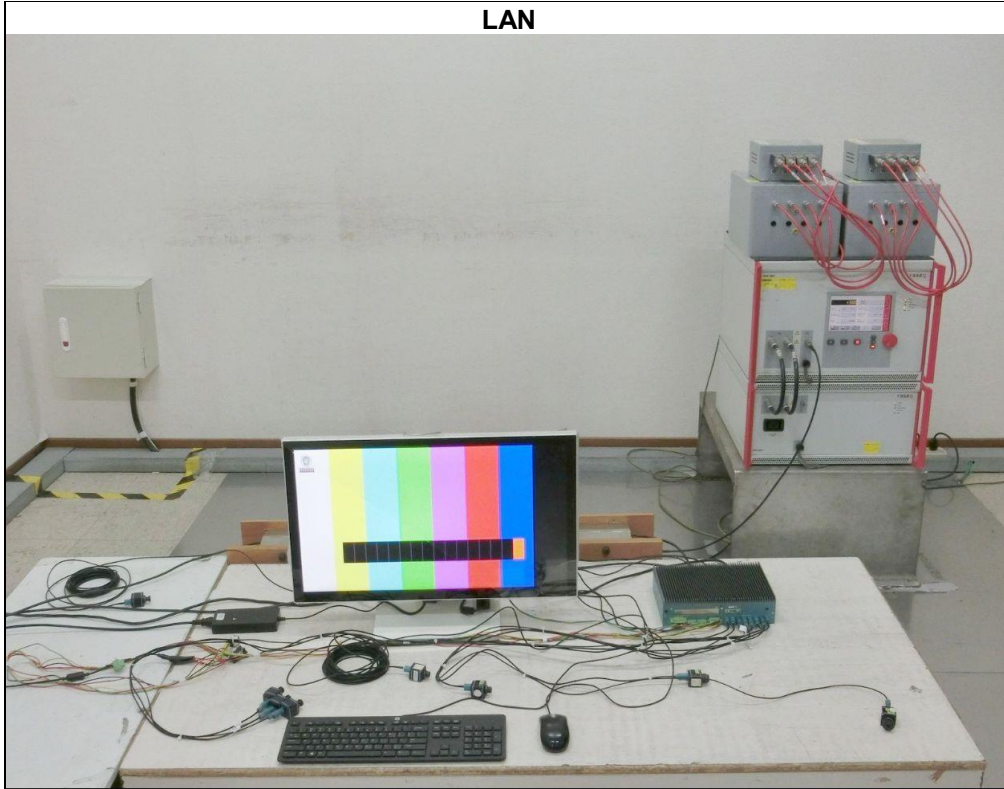

8.7 Surges

Mode A



8.8 Radio Frequency Common Mode (CS)

Mode A

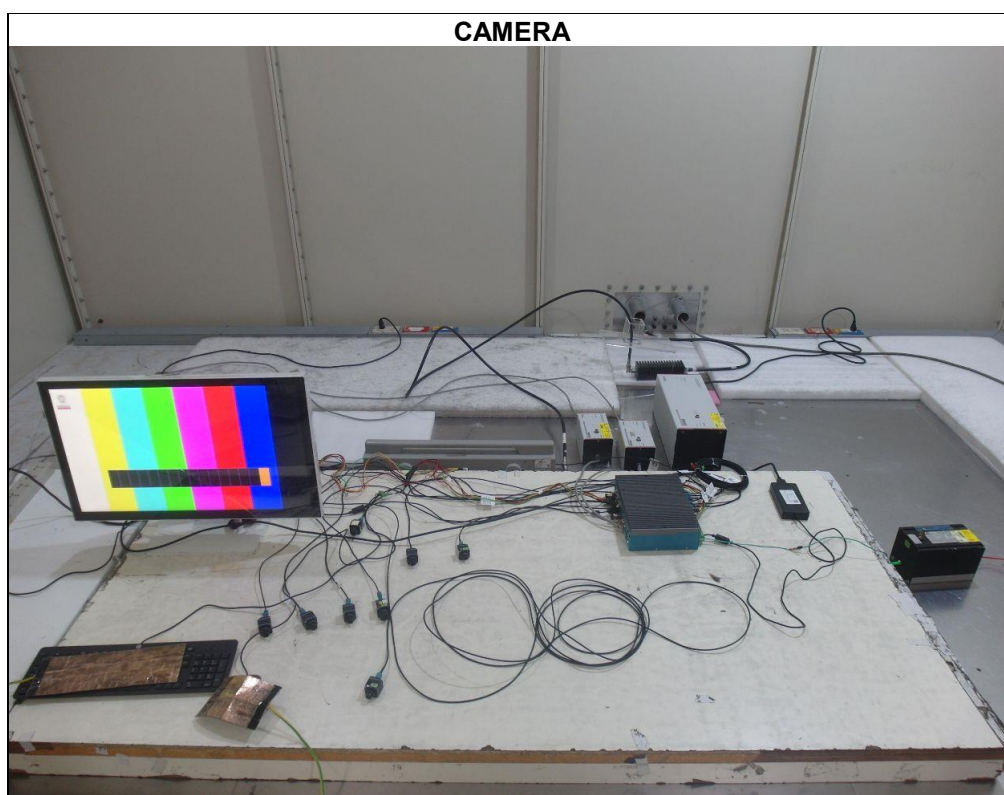
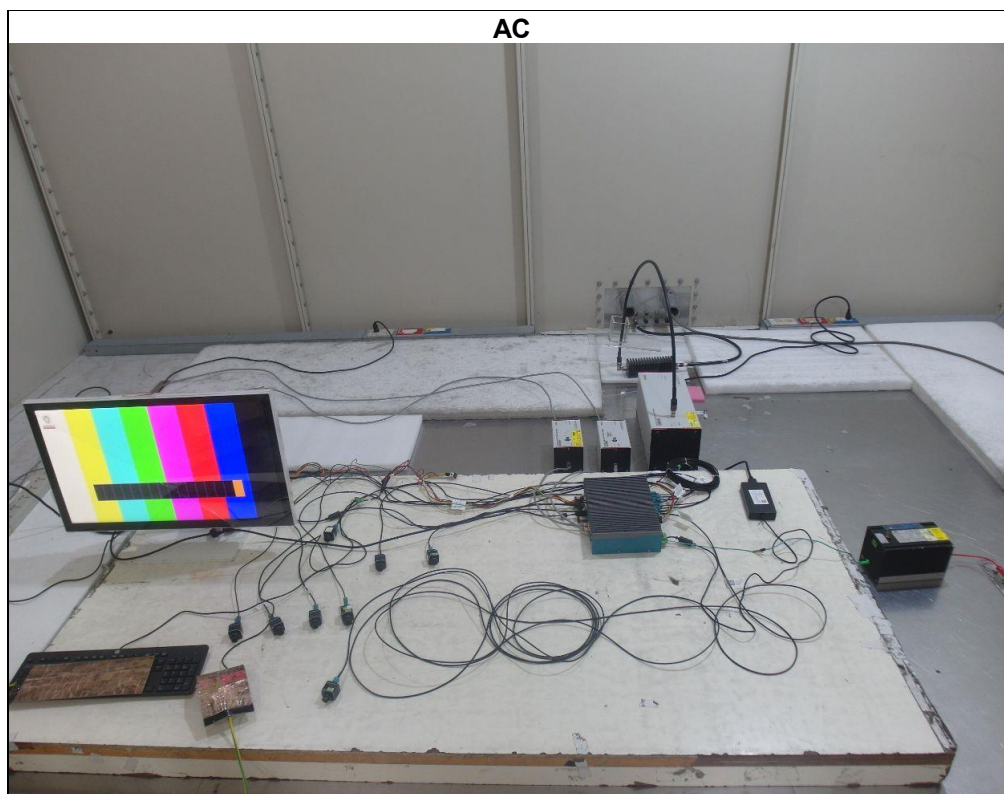

LAN

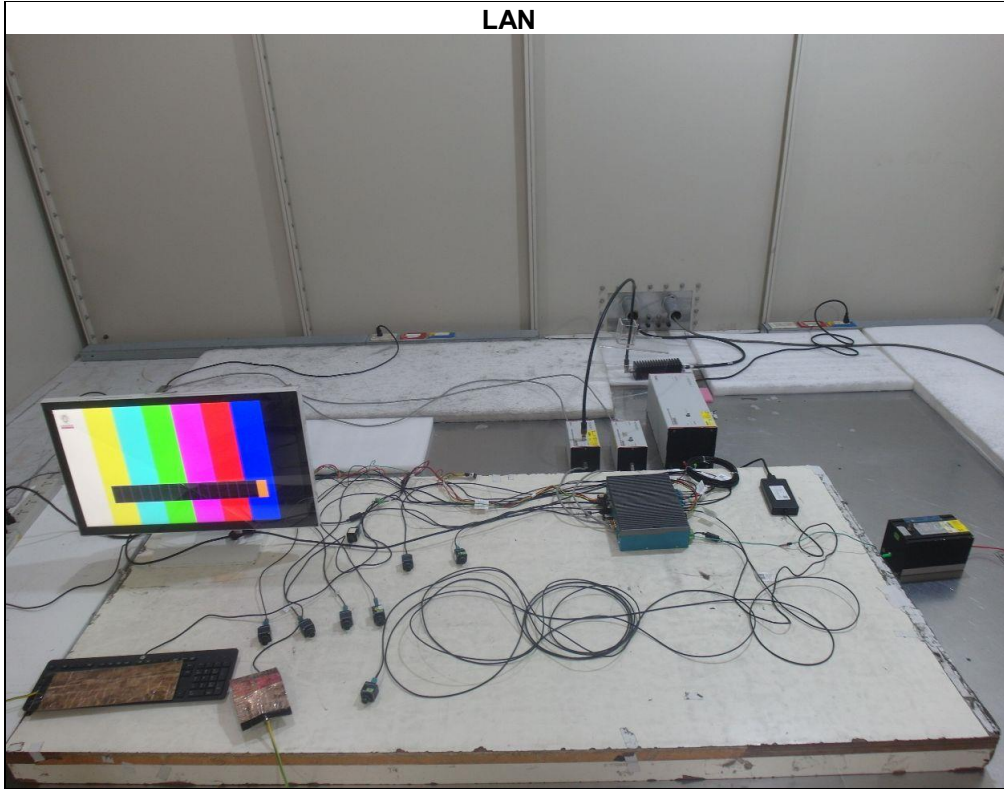

9 Information of the Testing Laboratories

We, Bureau Veritas Consumer Products Services (H.K.) Ltd., Taoyuan Branch, were founded in 1988 to provide our best service in EMC, Radio, Telecom and Safety consultation. Our laboratories are FCC recognized accredited test firms and accredited according to ISO/IEC 17025.

If you have any comments, please feel free to contact us at the following:

Lin Kou EMC/RF Lab

Tel: 886-2-26052180

Fax: 886-2-26051924

Hsin Chu EMC/RF/Telecom Lab

Tel: 886-3-6668565

Fax: 886-3-6668323

Hwa Ya EMC/RF/Safety Lab

Tel: 886-3-3183232

Fax: 886-3-3270892

Email: service.adt@bureauveritas.com

Web Site: <http://ee.bureauveritas.com.tw>

The address and road map of all our labs can be found in our web site also.

--- END ---